

ELEMENTY ZŁĄCZNE ORFS

CAT DPR

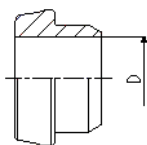

| Ciśnienie BAR | Rura [D]mm | Rura [D] cal | Oznaczenie CAT DPR | Oznaczenie CAT DPR |
|------------------|---------------|-----------------|------------------------------|------------------------------|
| 630 | 6 | 1/4" | CAT DPR 6 | CAT DPR 1/4 |
| | 8 | 5/16" | CAT DPR 8 | CAT DPR 5/16 |
| | 10 | 3/8" | CAT DPR 10 | CAT DPR 3/8 |
| | 12 | 1/2" | CAT DPR 12 | CAT DPR 1/2 |
| 420 | 14 | | CAT DPR 14 | |
| | 15 | | CAT DPR 15 | |
| | 16 | 5/8" | CAT DPR 16 | CAT DPR 5/8 |
| | 18 | | CAT DPR 18 | |
| | 20 | 3/4" | CAT DPR 20 | CAT DPR 3/4 |
| | 22 | 7/8" | CAT DPR 22 | CAT DPR 7/8 |
| | 25 | 1" | CAT DPR 25 | CAT DPR 1 |
| 280 | 28 | | CAT DPR 28 | |
| | 30 | 1 1/4" | CAT DPR 30 | CAT DPR 1 1/4 |
| | 32 | | CAT DPR 32 | |
| | 35 | | CAT DPR 35 | |
| | 38 | 1 1/2" | CAT DPR 38 | CAT DPR 1 1/2 |

CAT M

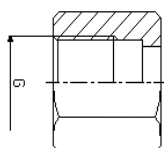

| Ciśnienie BAR | Rura [D]mm | Rura [D] cal | Gwint [G] | Oznaczenie CAT M |
|------------------|---------------|-----------------|--------------|----------------------------|
| 630 | 6 | 1/4" | 9/16-18 | CAT M 9/16 |
| | 8-10 | 5/16"-3/8" | 11/16-16 | CAT M 11/16 |
| | 12 | 1/2" | 13/16-16 | CAT M 13/16 |
| 420 | 14-15-16 | 5/8" | 1-14 | CAT M 1 |
| | 18-20 | 3/4" | 1 3/16-12 | CAT M 1 3/16 |
| | 22-25 | 7/8"-1" | 1 7/16-12 | CAT M 1 7/16 |
| 280 | 28-30-32 | 1 1/4" | 1 11/16-12 | CAT M 1 11/16 |
| | 35-38 | 1 1/2" | 2-12 | CAT M 2 |

CAT XGE M / ORFS

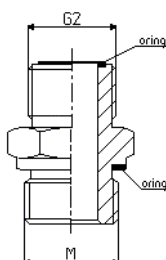

| Ciśnienie BAR | Gwint [M] | Gwint [G2] | Oznaczenie CAT XGE M / ORFS |
|------------------|--------------|---------------|---------------------------------------|
| 350 | 10x1 | 9/16"-18 | CAT XGE M10x1 / ORFS 9/16 |
| 630 | 12x1,5 | 9/16"-18 | CAT XGE M12x1,5 / ORFS 9/16 |
| | 12x1,5 | 11/16"-16 | CAT XGE M12x1,5 / ORFS 11/16 |
| | 14x1,5 | 9/16"-18 | CAT XGE M14x1,5 / ORFS 9/16 |
| | 14x1,5 | 11/16"-16 | CAT XGE M14x1,5 / ORFS 11/16 |
| | 14x1,5 | 13/16"-16 | CAT XGE M14x1,5 / ORFS 13/16 |
| | 16x1,5 | 11/16"-16 | CAT XGE M16x1,5 / ORFS 11/16 |
| | 16x1,5 | 13/16"-16 | CAT XGE M16x1,5 / ORFS 13/16 |
| | 18,1,5 | 11/16"-16 | CAT XGE M18x1,5 / ORFS 11/16 |
| | 18x1,5 | 13/16"-16 | CAT XGE M18x1,5 / ORFS 13/16 |
| | 18x1,5 | 1"-14 | CAT XGE M18x1,5 / ORFS 1 |
| 420 | 22x1,5 | 11/16"-16 | CAT XGE M22x1,5 / ORFS 11/16 |
| | 22x1,5 | 13/16"-16 | CAT XGE M22x1,5 / ORFS 13/16 |
| | 22,1,5 | 1"-14 | CAT XGE M22x1,5 / ORFS 1 |
| | 22x1,5 | 1 3/16"-12 | CAT XGE M22x1,5 / ORFS 1 3/16 |
| | 27x2 | 1"-14 | CAT XGE M27x2 / ORFS 1 |
| | 27x2 | 1 3/16"-12 | CAT XGE M27x2 / ORFS 1 3/16 |
| | 27x2 | 1 7/16"-12 | CAT XGE M27x2 / ORFS 1 7/16 |
| | 33x2 | 1 3/16"-12 | CAT XGE M33x2 / ORFS 1 3/16 |
| 280 | 33x2 | 1 7/16"-12 | CAT XGE M33x2 / ORFS 1 7/16 |
| | 33x2 | 1 11/16"-12 | CAT XGE M33x2 / ORFS 1 11/16 |
| | 42x2 | 1 7/16"-12 | CAT XGE M42x2 / ORFS 1 7/16 |
| | 42x2 | 1 11/16"-12 | CAT XGE M42x2 / ORFS 1 11/16 |
| | 48x2 | 1 11/16"-12 | CAT XGE M48x2 / ORFS 1 11/16 |
| | 48x2 | 2"-12 | CAT XGE M48x2 / ORFS 2 |

ELEMENTY ZŁĄCZNE ORFS

CAT XGE BSP / ORFS

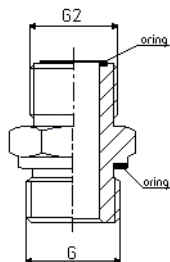

| Ciśnienie BAR | Gwint [G] | Gwint [G2] | Oznaczenie CAT XGE BSP / ORFS |
|------------------|--------------|---------------|---|
| 630 | 1/8" | 9/16"-18 | CAT XGE BSP 1/8 / ORFS 9/16 |
| | 1/8" | 11/16"-16 | CAT XGE BSP 1/8 / ORFS 11/16 |
| | 1/4" | 9/16"-18 | CAT XGE BSP 1/4 / ORFS 9/16 |
| | 1/4" | 11/16"-16 | CAT XGE BSP 1/4 / ORFS 11/16 |
| 420 | 1/4" | 13/16"-16 | CAT XGE BSP 1/4 / ORFS 13/16 |
| | 1/4" | 1"-14 | CAT XGE BSP 1/4 / ORFS 1 |
| | 1/4" | 1 3/16"-12 | CAT XGE BSP 1/4 / ORFS 1 3/16 |
| 630 | 1/4" | 1 7/16"-12 | CAT XGE BSP 1/4 / ORFS 1 7/16 |
| | 3/8" | 9/16"-18 | CAT XGE BSP 3/8 / ORFS 9/16 |
| | 3/8" | 11/16"-16 | CAT XGE BSP 3/8 / ORFS 11/16 |
| 420 | 3/8" | 13/16"-16 | CAT XGE BSP 3/8 / ORFS 13/16 |
| | 3/8" | 1"-14 | CAT XGE BSP 3/8 / ORFS 1 |
| | 3/8" | 1 3/16"-12 | CAT XGE BSP 3/8 / ORFS 1 3/16 |
| 630 | 3/8" | 1 7/16"-12 | CAT XGE BSP 3/8 / ORFS 1 7/16 |
| | 1/2" | 9/16"-18 | CAT XGE BSP 1/2 / ORFS 9/16 |
| | 1/2" | 11/16"-16 | CAT XGE BSP 1/2 / ORFS 11/16 |
| 420 | 1/2" | 13/16"-16 | CAT XGE BSP 1/2 / ORFS 13/16 |
| | 1/2" | 1"-14 | CAT XGE BSP 1/2 / ORFS 1 |
| | 1/2" | 1 3/16"-12 | CAT XGE BSP 1/2 / ORFS 1 3/16 |
| | 1/2" | 1 7/16"-12 | CAT XGE BSP 1/2 / ORFS 1 7/16 |
| | 3/4" | 11/16"-16 | CAT XGE BSP 3/4 / ORFS 11/16 |
| | 3/4" | 13/16"-16 | CAT XGE BSP 3/4 / ORFS 13/16 |
| | 3/4" | 1"-14 | CAT XGE BSP 3/4 / ORFS 1 |
| | 3/4" | 1 3/16"-12 | CAT XGE BSP 3/4 / ORFS 1 3/16 |
| | 3/4" | 1 7/16"-12 | CAT XGE BSP 3/4 / ORFS 1 7/16 |
| | 1" | 1"-14 | CAT XGE BSP 1 / ORFS 1 |
| | 1" | 1 3/16"-12 | CAT XGE BSP 1 / ORFS 1 3/16 |
| 280 | 1" | 1 7/16"-12 | CAT XGE BSP 1 / ORFS 1 7/16 |
| | 1" | 1 11/16"-12 | CAT XGE BSP 1 / ORFS 1 11/16 |
| | 1 1/4" | 1 3/16"-12 | CAT XGE BSP 1 1/4 / ORFS 1 3/16 |
| | 1 1/4" | 1 7/16"-12 | CAT XGE BSP 1 1/4 / ORFS 1 7/16 |
| | 1 1/4" | 1 11/16"-12 | CAT XGE BSP 1 1/4 / ORFS 1 11/16 |
| | 1 1/2" | 1 7/16"-12 | CAT XGE BSP 1 1/2 / ORFS 1 7/16 |
| | 1 1/2" | 1 11/16"-12 | CAT XGE BSP 1 1/2 / ORFS 1 11/16 |
| | 1 1/2" | 2"-12 | CAT XGE BSP 1 1/2 / ORFS 2 |

CAT XGE UNF / ORFS

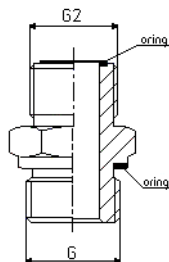

| Ciśnienie BAR | Gwint [G] | Gwint [G2] | Oznaczenie CAT XGE UNF / ORFS |
|------------------|--------------|---------------|---|
| 630 | 7/16"-20 | 9/16"-18 | CAT XGE UNF 7/16 / ORFS 9/16 |
| | 7/16"-20 | 11/16"-16 | CAT XGE UNF 7/16 / ORFS 11/16 |
| | 1/2"-20 | 9/16"-18 | CAT XGE UNF 1/2 / ORFS 9/16 |
| | 1/2"-20 | 11/16"-16 | CAT XGE UNF 1/2 / ORFS 11/16 |
| | 9/16"-18 | 9/16"-18 | CAT XGE UNF 9/16 / ORFS 9/16 |
| | 9/16"-18 | 11/16"-16 | CAT XGE UNF 9/16 / ORFS 11/16 |
| | 9/16"-18 | 13/16"-16 | CAT XGE UNF 9/16 / ORFS 13/16 |
| | 3/4"-16 | 9/16"-18 | CAT XGE UNF 3/4 / ORFS 9/16 |
| | 3/4"-16 | 11/16"-16 | CAT XGE UNF 3/4 / ORFS 11/16 |
| | 3/4"-16 | 13/16"-16 | CAT XGE UNF 3/4 / ORFS 13/16 |
| 420 | 3/4"-16 | 1"-14 | CAT XGE UNF 3/4 / ORFS 1 |
| | 3/4"-16 | 1 3/16"-12 | CAT XGE UNF 3/4 / ORFS 1 3/16 |
| 630 | 7/8"-14 | 11/16"-16 | CAT XGE UNF 7/8 / ORFS 11/16 |
| | 7/8"-14 | 13/16"-16 | CAT XGE UNF 7/8 / ORFS 13/16 |
| 420 | 7/8"-14 | 1"-14 | CAT XGE UNF 7/8 / ORFS 1 |
| | 7/8"-14 | 1 3/16"-12 | CAT XGE UNF 7/8 / ORFS 1 3/16 |
| | 1 1/16"-12 | 11/16"-16 | CAT XGE UNF 1 1/16 / ORFS 11/16 |
| | 1 1/16"-12 | 13/16"-16 | CAT XGE UNF 1 1/16 / ORFS 13/16 |
| | 1 1/16"-12 | 1"-14 | CAT XGE UNF 1 1/16 / ORFS 1 |
| | 1 1/16"-12 | 1 3/16"-12 | CAT XGE UNF 1 1/16 / ORFS 1 3/16 |
| | 1 1/16"-12 | 1 7/16"-12 | CAT XGE UNF 1 1/16 / ORFS 1 7/16 |
| | 1 5/16"-12 | 13/16"-16 | CAT XGE UNF 1 5/16 / ORFS 13/16 |
| | 1 5/16"-12 | 1"-14 | CAT XGE UNF 1 5/16 / ORFS 1 |
| | 1 5/16"-12 | 1 3/16"-12 | CAT XGE UNF 1 5/16 / ORFS 1 3/16 |
| 280 | 1 5/16"-12 | 1 7/16"-12 | CAT XGE UNF 1 5/16 / ORFS 1 7/16 |
| | 1 5/8"-12 | 1 11/16"-12 | CAT XGE UNF 1 5/8 / ORFS 1 11/16 |
| | 1 5/8"-12 | 1 7/16"-12 | CAT XGE UNF 1 5/8 / ORFS 1 7/16 |
| | 1 5/8"-12 | 1 11/16"-12 | CAT XGE UNF 1 5/8 / ORFS 1 11/16 |
| | 1 5/8"-12 | 2"-12 | CAT XGE UNF 1 5/8 / ORFS 2 |
| | 1 7/8"-12 | 1 11/16"-12 | CAT XGE UNF 1 7/8 / ORFS 1 11/16 |
| | 1 7/8"-12 | 2"-12 | CAT XGE UNF 1 7/8 / ORFS 2 |

ELEMENTY ZŁĄCZNE ORFS

CAT XGE NPT / ORFS

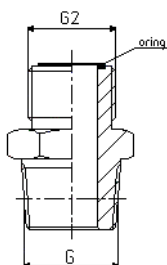

| Ciśnienie BAR | Gwint [G] | Gwint [G2] | Oznaczenie CAT XGE NPT / ORFS |
|------------------|--------------|---------------|---|
| 630 | 1/8" | 9/16"-18 | CAT XGE NPT 1/8 / ORFS 9/16 |
| | 1/8" | 11/16"-16 | CAT XGE NPT 1/8 / ORFS 11/16 |
| | 1/4" | 9/16"-18 | CAT XGE NPT 1/4 / ORFS 9/16 |
| | 1/4" | 11/16"-16 | CAT XGE NPT 1/4 / ORFS 11/16 |
| 420 | 1/4" | 13/16"-16 | CAT XGE NPT 1/4 / ORFS 13/16 |
| | 1/4" | 1"-14 | CAT XGE NPT 1/4 / ORFS 1 |
| | 1/4" | 1 3/16"-12 | CAT XGE NPT 1/4 / ORFS 1 3/16 |
| 630 | 1/4" | 1 7/16"-12 | CAT XGE NPT 1/4 / ORFS 1 7/16 |
| | 3/8" | 9/16"-18 | CAT XGE NPT 3/8 / ORFS 9/16 |
| | 3/8" | 11/16"-16 | CAT XGE NPT 3/8 / ORFS 11/16 |
| 420 | 3/8" | 13/16"-16 | CAT XGE NPT 3/8 / ORFS 13/16 |
| | 3/8" | 1"-14 | CAT XGE NPT 3/8 / ORFS 1 |
| | 3/8" | 1 3/16"-12 | CAT XGE NPT 3/8 / ORFS 1 3/16 |
| 630 | 3/8" | 1 7/16"-12 | CAT XGE NPT 3/8 / ORFS 1 7/16 |
| | 1/2" | 9/16"-18 | CAT XGE NPT 1/2 / ORFS 9/16 |
| | 1/2" | 11/16"-16 | CAT XGE NPT 1/2 / ORFS 11/16 |
| 420 | 1/2" | 13/16"-16 | CAT XGE NPT 1/2 / ORFS 13/16 |
| | 1/2" | 1"-14 | CAT XGE NPT 1/2 / ORFS 1 |
| | 1/2" | 1 3/16"-12 | CAT XGE NPT 1/2 / ORFS 1 3/16 |
| | 1/2" | 1 7/16"-12 | CAT XGE NPT 1/2 / ORFS 1 7/16 |
| | 3/4" | 11/16"-16 | CAT XGE NPT 3/4 / ORFS 11/16 |
| | 3/4" | 13/16"-16 | CAT XGE NPT 3/4 / ORFS 13/16 |
| | 3/4" | 1"-14 | CAT XGE NPT 3/4 / ORFS 1 |
| | 3/4" | 1 3/16"-12 | CAT XGE NPT 3/4 / ORFS 1 3/16 |
| | 3/4" | 1 7/16"-12 | CAT XGE NPT 3/4 / ORFS 1 7/16 |
| | 1" | 1"-14 | CAT XGE NPT 1 / ORFS 1 |
| | 1" | 1 3/16"-12 | CAT XGE NPT 1 / ORFS 1 3/16 |
| 280 | 1" | 1 7/16"-12 | CAT XGE NPT 1 / ORFS 1 7/16 |
| | 1" | 1 11/16"-12 | CAT XGE NPT 1 / ORFS 1 11/16 |
| | 1 1/4" | 1 3/16"-12 | CAT XGE NPT 1 1/4 / ORFS 1 3/16 |
| | 1 1/4" | 1 7/16"-12 | CAT XGE NPT 1 1/4 / ORFS 1 7/16 |
| | 1 1/4" | 1 11/16"-12 | CAT XGE NPT 1 1/4 / ORFS 1 11/16 |
| | 1 1/2" | 1 7/16"-12 | CAT XGE NPT 1 1/2 / ORFS 1 7/16 |
| | 1 1/2" | 1 11/16"-12 | CAT XGE NPT 1 1/2 / ORFS 1 11/16 |
| | 1 1/2" | 2"-12 | CAT XGE NPT 1 1/2 / ORFS 2 |

CAT EGE M / ORFS

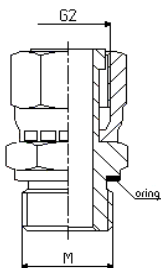

| Ciśnienie BAR | Gwint [M] | Gwint [G2] | Oznaczenie CAT EGE M / ORFS |
|------------------|--------------|---------------|---------------------------------------|
| 350 | 10x1 | 9/16"-18 | CAT EGE M10x1 / ORFS 9/16 |
| 630 | 12x1,5 | 9/16"-18 | CAT EGE M12x1,5 / ORFS 9/16 |
| | 12x1,5 | 11/16"-16 | CAT EGE M12x1,5 / ORFS 11/16 |
| | 14x1,5 | 9/16"-18 | CAT EGE M14x1,5 / ORFS 9/16 |
| | 14x1,5 | 11/16"-16 | CAT EGE M14x1,5 / ORFS 11/16 |
| | 14x1,5 | 13/16"-16 | CAT EGE M14x1,5 / ORFS 13/16 |
| | 16x1,5 | 11/16"-16 | CAT EGE M16x1,5 / ORFS 11/16 |
| | 16x1,5 | 13/16"-16 | CAT EGE M16x1,5 / ORFS 13/16 |
| | 18,1,5 | 11/16"-16 | CAT EGE M18x1,5 / ORFS 11/16 |
| 420 | 18x1,5 | 13/16"-16 | CAT EGE M18x1,5 / ORFS 13/16 |
| | 18x1,5 | 1"-14 | CAT EGE M18x1,5 / ORFS 1 |
| | 22x1,5 | 11/16"-16 | CAT EGE M22x1,5 / ORFS 11/16 |
| | 22x1,5 | 13/16"-16 | CAT EGE M22x1,5 / ORFS 13/16 |
| | 22,1,5 | 1"-14 | CAT EGE M22x1,5 / ORFS 1 |
| | 22x1,5 | 1 3/16"-12 | CAT EGE M22x1,5 / ORFS 1 3/16 |
| | 27x2 | 1"-14 | CAT EGE M27x2 / ORFS 1 |
| | 27x2 | 1 3/16"-12 | CAT EGE M27x2 / ORFS 1 3/16 |
| | 27x2 | 1 7/16"-12 | CAT EGE M27x2 / ORFS 1 7/16 |
| | 33x2 | 1 3/16"-12 | CAT EGE M33x2 / ORFS 1 3/16 |
| | 33x2 | 1 7/16"-12 | CAT EGE M33x2 / ORFS 1 7/16 |
| 280 | 33x2 | 1 11/16"-12 | CAT EGE M33x2 / ORFS 1 11/16 |
| | 42x2 | 1 7/16"-12 | CAT EGE M42x2 / ORFS 1 7/16 |
| | 42x2 | 1 11/16"-12 | CAT EGE M42x2 / ORFS 1 11/16 |
| | 48x2 | 1 11/16"-12 | CAT EGE M48x2 / ORFS 1 11/16 |
| | 48x2 | 2"-12 | CAT EGE M48x2 / ORFS 2 |

ELEMENTY ZŁĄCZNE ORFS

CAT EGE BSP / ORFS

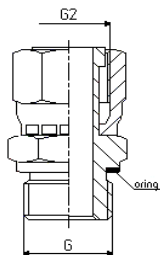

| Ciężnienie BAR | Gwint [G] | Gwint [G2] | Oznaczenie CAT EGE BSP / ORFS |
|-------------------|--------------|---------------|---|
| 630 | 1/8" | 9/16"-18 | CAT EGE BSP 1/8 / ORFS 9/16 |
| | 1/8" | 11/16"-16 | CAT EGE BSP 1/8 / ORFS 11/16 |
| | 1/4" | 9/16"-18 | CAT EGE BSP 1/4 / ORFS 9/16 |
| | 1/4" | 11/16"-16 | CAT EGE BSP 1/4 / ORFS 11/16 |
| | 1/4" | 13/16"-16 | CAT EGE BSP 1/4 / ORFS 13/16 |
| 420 | 1/4" | 1"-14 | CAT EGE BSP 1/4 / ORFS 1 |
| | 1/4" | 1 3/16"-12 | CAT EGE BSP 1/4 / ORFS 1 3/16 |
| | 1/4" | 1 7/16"-12 | CAT EGE BSP 1/4 / ORFS 1 7/16 |
| 630 | 3/8" | 9/16"-18 | CAT EGE BSP 3/8 / ORFS 9/16 |
| | 3/8" | 11/16"-16 | CAT EGE BSP 3/8 / ORFS 11/16 |
| | 3/8" | 13/16"-16 | CAT EGE BSP 3/8 / ORFS 13/16 |
| 420 | 3/8" | 1"-14 | CAT EGE BSP 3/8 / ORFS 1 |
| | 3/8" | 1 3/16"-12 | CAT EGE BSP 3/8 / ORFS 1 3/16 |
| | 3/8" | 1 7/16"-12 | CAT EGE BSP 3/8 / ORFS 1 7/16 |
| 630 | 1/2" | 9/16"-18 | CAT EGE BSP 1/2 / ORFS 9/16 |
| | 1/2" | 11/16"-16 | CAT EGE BSP 1/2 / ORFS 11/16 |
| | 1/2" | 13/16"-16 | CAT EGE BSP 1/2 / ORFS 13/16 |
| 420 | 1/2" | 1"-14 | CAT EGE BSP 1/2 / ORFS 1 |
| | 1/2" | 1 3/16"-12 | CAT EGE BSP 1/2 / ORFS 1 3/16 |
| | 1/2" | 1 7/16"-12 | CAT EGE BSP 1/2 / ORFS 1 7/16 |
| | 3/4" | 11/16"-16 | CAT EGE BSP 3/4 / ORFS 11/16 |
| | 3/4" | 13/16"-16 | CAT EGE BSP 3/4 / ORFS 13/16 |
| | 3/4" | 1"-14 | CAT EGE BSP 3/4 / ORFS 1 |
| | 3/4" | 1 3/16"-12 | CAT EGE BSP 3/4 / ORFS 1 3/16 |
| | 3/4" | 1 7/16"-12 | CAT EGE BSP 3/4 / ORFS 1 7/16 |
| | 1" | 1"-14 | CAT EGE BSP 1 / ORFS 1 |
| | 1" | 1 3/16"-12 | CAT EGE BSP 1 / ORFS 1 3/16 |
| 280 | 1" | 1 7/16"-12 | CAT EGE BSP 1 / ORFS 1 7/16 |
| | 1 1/4" | 1 11/16"-12 | CAT EGE BSP 1 1/4 / ORFS 1 11/16 |
| | 1 1/4" | 1 3/16"-12 | CAT EGE BSP 1 1/4 / ORFS 1 3/16 |
| | 1 1/4" | 1 7/16"-12 | CAT EGE BSP 1 1/4 / ORFS 1 7/16 |
| | 1 1/2" | 1 7/16"-12 | CAT EGE BSP 1 1/2 / ORFS 1 7/16 |
| | 1 1/2" | 1 11/16"-12 | CAT EGE BSP 1 1/2 / ORFS 1 11/16 |
| | 1 1/2" | 2"-12 | CAT EGE BSP 1 1/2 / ORFS 2 |

CAT EGE UNF / ORFS

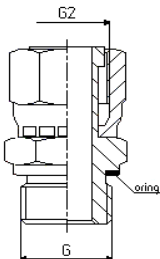

| Ciężnienie BAR | Gwint [G] | Gwint [G2] | Oznaczenie CAT EGE UNF / ORFS |
|-------------------|--------------|---------------|---|
| 630 | 7/16"-20 | 9/16"-18 | CAT EGE UNF 7/16 / ORFS 9/16 |
| | 7/16"-20 | 11/16"-16 | CAT EGE UNF 7/16 / ORFS 11/16 |
| | 1/2"-20 | 9/16"-18 | CAT EGE UNF 1/2 / ORFS 9/16 |
| | 1/2"-20 | 11/16"-16 | CAT EGE UNF 1/2 / ORFS 11/16 |
| | 9/16"-18 | 9/16"-18 | CAT EGE UNF 9/16 / ORFS 9/16 |
| | 9/16"-18 | 11/16"-16 | CAT EGE UNF 9/16 / ORFS 11/16 |
| | 9/16"-18 | 13/16"-16 | CAT EGE UNF 9/16 / ORFS 13/16 |
| | 3/4"-16 | 9/16"-18 | CAT EGE UNF 3/4 / ORFS 9/16 |
| | 3/4"-16 | 11/16"-16 | CAT EGE UNF 3/4 / ORFS 11/16 |
| | 3/4"-16 | 13/16"-16 | CAT EGE UNF 3/4 / ORFS 13/16 |
| 420 | 3/4"-16 | 1"-14 | CAT EGE UNF 3/4 / ORFS 1 |
| | 3/4"-16 | 1 3/16"-12 | CAT EGE UNF 3/4 / ORFS 1 3/16 |
| 630 | 7/8"-14 | 11/16"-16 | CAT EGE UNF 7/8 / ORFS 11/16 |
| | 7/8"-14 | 13/16"-16 | CAT EGE UNF 7/8 / ORFS 13/16 |
| 420 | 7/8"-14 | 1"-14 | CAT EGE UNF 7/8 / ORFS 1 |
| | 7/8"-14 | 1 3/16"-12 | CAT EGE UNF 7/8 / ORFS 1 3/16 |
| | 1 1/16"-12 | 11/16"-16 | CAT EGE UNF 1 1/16 / ORFS 11/16 |
| | 1 1/16"-12 | 13/16"-16 | CAT EGE UNF 1 1/16 / ORFS 13/16 |
| | 1 1/16"-12 | 1"-14 | CAT EGE UNF 1 1/16 / ORFS 1 |
| | 1 1/16"-12 | 1 3/16"-12 | CAT EGE UNF 1 1/16 / ORFS 1 3/16 |
| | 1 1/16"-12 | 1 7/16"-12 | CAT EGE UNF 1 1/16 / ORFS 1 7/16 |
| | 1 5/16"-12 | 13/16"-16 | CAT EGE UNF 1 5/16 / ORFS 13/16 |
| | 1 5/16"-12 | 1"-14 | CAT EGE UNF 1 5/16 / ORFS 1 |
| | 1 5/16"-12 | 1 3/16"-12 | CAT EGE UNF 1 5/16 / ORFS 1 3/16 |
| 280 | 1 5/16"-12 | 1 7/16"-12 | CAT EGE UNF 1 5/16 / ORFS 1 7/16 |
| | 1 5/8"-12 | 1 11/16"-12 | CAT EGE UNF 1 5/8 / ORFS 1 11/16 |
| | 1 5/8"-12 | 2"-12 | CAT EGE UNF 1 5/8 / ORFS 2 |
| | 1 7/8"-12 | 1 11/16"-12 | CAT EGE UNF 1 7/8 / ORFS 1 11/16 |
| | 1 7/8"-12 | 2"-12 | CAT EGE UNF 1 7/8 / ORFS 2 |

ELEMENTY ZŁĄCZNE ORFS

CAT XGAI BSP / ORFS
CAT XGAI NPT / ORFS

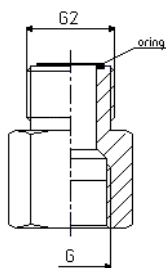

| Ciężnienie BAR | Gwint [G] | Gwint [G2] | Oznaczenie | |
|-------------------|--------------|---------------|-----------------------------------|-----------------------------------|
| | | | CAT XGAI BSP / ORFS | CAT XGAI NPT / ORFS |
| 630 | 1/8" | 9/16"-18 | CAT XGAI BSP 1/8 / ORFS 9/16 | CAT XGAI NPT 1/8 / ORFS 9/16 |
| | 1/8" | 11/16"-16 | CAT XGAI BSP 1/8 / ORFS 11/16 | CAT XGAI NPT 1/8 / ORFS 11/16 |
| | 1/4" | 9/16"-18 | CAT XGAI BSP 1/4 / ORFS 9/16 | CAT XGAI NPT 1/4 / ORFS 9/16 |
| | 1/4" | 11/16"-16 | CAT XGAI BSP 1/4 / ORFS 11/16 | CAT XGAI NPT 1/4 / ORFS 11/16 |
| | 1/4" | 13/16"-16 | CAT XGAI BSP 1/4 / ORFS 13/16 | CAT XGAI NPT 1/4 / ORFS 13/16 |
| 420 | 1/4" | 1"-14 | CAT XGAI BSP 1/4 / ORFS 1 | CAT XGAI NPT 1/4 / ORFS 1 |
| | 1/4" | 1 3/16"-12 | CAT XGAI BSP 1/4 / ORFS 1 3/16 | CAT XGAI NPT 1/4 / ORFS 1 3/16 |
| | 1/4" | 1 7/16"-12 | CAT XGAI BSP 1/4 / ORFS 1 7/16 | CAT XGAI NPT 1/4 / ORFS 1 7/16 |
| 630 | 3/8" | 9/16"-18 | CAT XGAI BSP 3/8 / ORFS 9/16 | CAT XGAI NPT 3/8 / ORFS 9/16 |
| | 3/8" | 11/16"-16 | CAT XGAI BSP 3/8 / ORFS 11/16 | CAT XGAI NPT 3/8 / ORFS 11/16 |
| | 3/8" | 13/16"-16 | CAT XGAI BSP 3/8 / ORFS 13/16 | CAT XGAI NPT 3/8 / ORFS 13/16 |
| 420 | 3/8" | 1"-14 | CAT XGAI BSP 3/8 / ORFS 1 | CAT XGAI NPT 3/8 / ORFS 1 |
| | 3/8" | 1 3/16"-12 | CAT XGAI BSP 3/8 / ORFS 1 3/16 | CAT XGAI NPT 3/8 / ORFS 1 3/16 |
| | 3/8" | 1 7/16"-12 | CAT XGAI BSP 3/8 / ORFS 1 7/16 | CAT XGAI NPT 3/8 / ORFS 1 7/16 |
| 630 | 1/2" | 9/16"-18 | CAT XGAI BSP 1/2 / ORFS 9/16 | CAT XGAI NPT 1/2 / ORFS 9/16 |
| | 1/2" | 11/16"-16 | CAT XGAI BSP 1/2 / ORFS 11/16 | CAT XGAI NPT 1/2 / ORFS 11/16 |
| | 1/2" | 13/16"-16 | CAT XGAI BSP 1/2 / ORFS 13/16 | CAT XGAI NPT 1/2 / ORFS 13/16 |
| 420 | 1/2" | 1"-14 | CAT XGAI BSP 1/2 / ORFS 1 | CAT XGAI NPT 1/2 / ORFS 1 |
| | 1/2" | 1 3/16"-12 | CAT XGAI BSP 1/2 / ORFS 1 3/16 | CAT XGAI NPT 1/2 / ORFS 1 3/16 |
| | 1/2" | 1 7/16"-12 | CAT XGAI BSP 1/2 / ORFS 1 7/16 | CAT XGAI NPT 1/2 / ORFS 1 7/16 |
| | 3/4" | 11/16"-16 | CAT XGAI BSP 3/4 / ORFS 11/16 | CAT XGAI NPT 3/4 / ORFS 11/16 |
| | 3/4" | 13/16"-16 | CAT XGAI BSP 3/4 / ORFS 13/16 | CAT XGAI NPT 3/4 / ORFS 13/16 |
| | 3/4" | 1"-14 | CAT XGAI BSP 3/4 / ORFS 1 | CAT XGAI NPT 3/4 / ORFS 1 |
| | 3/4" | 1 3/16"-12 | CAT XGAI BSP 3/4 / ORFS 1 3/16 | CAT XGAI NPT 3/4 / ORFS 1 3/16 |
| | 3/4" | 1 7/16"-12 | CAT XGAI BSP 3/4 / ORFS 1 7/16 | CAT XGAI NPT 3/4 / ORFS 1 7/16 |
| | 1" | 1"-14 | CAT XGAI BSP 1 / ORFS 1 | CAT XGAI NPT 1 / ORFS 1 |
| | 1" | 1 3/16"-12 | CAT XGAI BSP 1 / ORFS 1 3/16 | CAT XGAI NPT 1 / ORFS 1 3/16 |
| 280 | 1" | 1 7/16"-12 | CAT XGAI BSP 1 / ORFS 1 7/16 | CAT XGAI NPT 1 / ORFS 1 7/16 |
| | 1 1/4" | 1 11/16"-12 | CAT XGAI BSP 1 1/4 / ORFS 1 11/16 | CAT XGAI NPT 1 1/4 / ORFS 1 11/16 |
| | 1 1/4" | 1 3/16"-12 | CAT XGAI BSP 1 1/4 / ORFS 1 3/16 | CAT XGAI NPT 1 1/4 / ORFS 1 3/16 |
| | 1 1/4" | 1 7/16"-12 | CAT XGAI BSP 1 1/4 / ORFS 1 7/16 | CAT XGAI NPT 1 1/4 / ORFS 1 7/16 |
| | 1 1/2" | 1 7/16"-12 | CAT XGAI BSP 1 1/2 / ORFS 1 7/16 | CAT XGAI NPT 1 1/2 / ORFS 1 7/16 |
| | 1 1/2" | 1 11/16"-12 | CAT XGAI BSP 1 1/2 / ORFS 1 11/16 | CAT XGAI NPT 1 1/2 / ORFS 1 11/16 |
| | 1 1/2" | 2"-12 | CAT XGAI BSP 1 1/2 / ORFS 2 | CAT XGAI NPT 1 1/2 / ORFS 2 |

CAT RI ORFS / ORFS

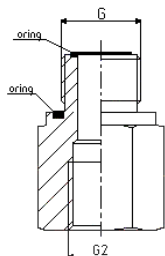

| Ciężnienie BAR | Gwint [G] | Gwint [G2] | Oznaczenie | |
|-------------------|--------------|---------------|-----------------------------------|--|
| | | | CAT RI ORFS / ORFS | |
| 630 | 9/16"-18 | 11/16"-16 | CAT RI ORFS 9/16 / ORFS 11/16 | |
| | 9/16"-18 | 13/16"-16 | CAT RI ORFS 9/16 / ORFS 13/16 | |
| 420 | 9/16"-18 | 1"-14 | CAT RI ORFS 9/16 / ORFS 1 | |
| | 9/16"-18 | 1 3/16"-12 | CAT RI ORFS 9/16 / ORFS 1 3/16 | |
| 280 | 9/16"-18 | 1 7/16"-12 | CAT RI ORFS 9/16 / ORFS 1 7/16 | |
| | 9/16"-18 | 1 11/16"-12 | CAT RI ORFS 9/16 / ORFS 1 11/16 | |
| 630 | 9/16"-18 | 2"-12 | CAT RI ORFS 9/16 / ORFS 2 | |
| | 11/16"-16 | 13/16"-16 | CAT RI ORFS 11/16 / ORFS 13/16 | |
| 420 | 11/16"-16 | 1"-14 | CAT RI ORFS 11/16 / ORFS 1 | |
| | 11/16"-16 | 1 3/16"-12 | CAT RI ORFS 11/16 / ORFS 1 3/16 | |
| | 11/16"-16 | 1 7/16"-12 | CAT RI ORFS 11/16 / ORFS 1 7/16 | |
| 280 | 11/16"-16 | 1 11/16"-12 | CAT RI ORFS 11/16 / ORFS 1 11/16 | |
| | 11/16"-16 | 2"-12 | CAT RI ORFS 11/16 / ORFS 2 | |
| 420 | 13/16"-16 | 1"-14 | CAT RI ORFS 13/16 / ORFS 1 | |
| | 13/16"-16 | 1 3/16"-12 | CAT RI ORFS 13/16 / ORFS 1 3/16 | |
| 280 | 13/16"-16 | 1 7/16"-12 | CAT RI ORFS 13/16 / ORFS 1 7/16 | |
| | 13/16"-16 | 1 11/16"-12 | CAT RI ORFS 13/16 / ORFS 1 11/16 | |
| 420 | 1"-14 | 1 3/16"-12 | CAT RI ORFS 1 / ORFS 1 3/16 | |
| | 1"-14 | 1 7/16"-12 | CAT RI ORFS 1 / ORFS 1 7/16 | |
| 280 | 1"-14 | 1 11/16"-12 | CAT RI ORFS 1 / ORFS 1 11/16 | |
| | 1"-14 | 2"-12 | CAT RI ORFS 1 / ORFS 2 | |
| 280 | 1 3/16"-12 | 1 7/16"-12 | CAT RI ORFS 1 3/16 / ORFS 1 7/16 | |
| | 1 3/16"-12 | 1 11/16"-12 | CAT RI ORFS 1 3/16 / ORFS 1 11/16 | |
| | 1 3/16"-12 | 2"-12 | CAT RI ORFS 1 3/16 / ORFS 2 | |
| | 1 7/16"-12 | 1 11/16"-12 | CAT RI ORFS 1 7/16 / ORFS 1 11/16 | |
| | 1 7/16"-12 | 2"-12 | CAT RI ORFS 1 7/16 / ORFS 2 | |

ELEMENTY ZŁĄCZNE ORFS

CAT XSVGW BSP / ORFS
CAT XSVGW NPT / ORFS

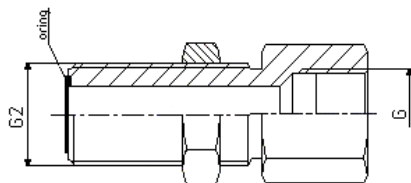

| Ciężnienie BAR | Gwint [G] | Gwint [G2] | Oznaczenie | |
|-------------------|--------------|---------------|------------------------------------|------------------------------------|
| | | | CAT XSVGW BSP / ORFS | CAT XSVGW NPT / ORFS |
| 630 | 1/4" | 9/16"-18 | CAT XSVGW BSP 1/4 / ORFS 9/16 | CAT XSVGW NPT 1/4 / ORFS 9/16 |
| | 3/8" | 9/16"-18 | CAT XSVGW BSP 3/8 / ORFS 9/16 | CAT XSVGW NPT 3/8 / ORFS 9/16 |
| 420 | 1/2" | 9/16"-18 | CAT XSVGW BSP 1/2 / ORFS 9/16 | CAT XSVGW NPT 1/2 / ORFS 9/16 |
| | 5/8" | 9/16"-18 | CAT XSVGW BSP 5/8 / ORFS 9/16 | CAT XSVGW NPT 5/8 / ORFS 9/16 |
| | 3/4" | 9/16"-18 | CAT XSVGW BSP 3/4 / ORFS 9/16 | CAT XSVGW NPT 3/4 / ORFS 9/16 |
| 630 | 3/8" | 11/16"-16 | CAT XSVGW BSP 3/8 / ORFS 11/16 | CAT XSVGW NPT 3/8 / ORFS 11/16 |
| | 1/2" | 11/16"-16 | CAT XSVGW BSP 1/2 / ORFS 11/16 | CAT XSVGW NPT 1/2 / ORFS 11/16 |
| | 5/8" | 11/16"-16 | CAT XSVGW BSP 5/8 / ORFS 11/16 | CAT XSVGW NPT 5/8 / ORFS 11/16 |
| | 3/4" | 11/16"-16 | CAT XSVGW BSP 3/4 / ORFS 11/16 | CAT XSVGW NPT 3/4 / ORFS 11/16 |
| | 1/2" | 13/16"-16 | CAT XSVGW BSP 1/2 / ORFS 13/16 | CAT XSVGW NPT 1/2 / ORFS 13/16 |
| | 5/8" | 13/16"-16 | CAT XSVGW BSP 5/8 / ORFS 13/16 | CAT XSVGW NPT 5/8 / ORFS 13/16 |
| | 3/4" | 13/16"-16 | CAT XSVGW BSP 3/4 / ORFS 13/16 | CAT XSVGW NPT 3/4 / ORFS 13/16 |
| | 1" | 13/16"-16 | CAT XSVGW BSP 1 / ORFS 13/16 | CAT XSVGW NPT 1 / ORFS 13/16 |
| | 5/8" | 1"-14 | CAT XSVGW BSP 5/8 / ORFS 1 | CAT XSVGW NPT 5/8 / ORFS 1 |
| | 3/4" | 1"-14 | CAT XSVGW BSP 3/4 / ORFS 1 | CAT XSVGW NPT 3/4 / ORFS 1 |
| | 1" | 1"-14 | CAT XSVGW BSP 1 / ORFS 1 | CAT XSVGW NPT 1 / ORFS 1 |
| | 3/4" | 1 3/16"-12 | CAT XSVGW BSP 3/4 / ORFS 1 3/16 | CAT XSVGW NPT 3/4 / ORFS 1 3/16 |
| | 1" | 1 3/16"-12 | CAT XSVGW BSP 1 / ORFS 1 3/16 | CAT XSVGW NPT 1 / ORFS 1 3/16 |
| 280 | 1 1/4" | 1 3/16"-12 | CAT XSVGW BSP 1 1/4 / ORFS 1 3/16 | CAT XSVGW NPT 1 1/4 / ORFS 1 3/16 |
| 420 | 1" | 1 7/16"-12 | CAT XSVGW BSP 1 / ORFS 1 7/16 | CAT XSVGW NPT 1 / ORFS 1 7/16 |
| 280 | 1 1/4" | 1 7/16"-12 | CAT XSVGW BSP 1 1/4 / ORFS 1 7/16 | CAT XSVGW NPT 1 1/4 / ORFS 1 7/16 |
| | 1 1/2" | 1 7/16"-12 | CAT XSVGW BSP 1 1/2 / ORFS 1 7/16 | CAT XSVGW NPT 1 1/2 / ORFS 1 7/16 |
| | 1 1/4" | 1 11/16"-12 | CAT XSVGW BSP 1 1/4 / ORFS 1 11/16 | CAT XSVGW NPT 1 1/4 / ORFS 1 11/16 |
| | 1 1/2" | 1 11/16"-12 | CAT XSVGW BSP 1 1/2 / ORFS 1 11/16 | CAT XSVGW NPT 1 1/2 / ORFS 1 11/16 |
| | 2" | 1 11/16"-12 | CAT XSVGW BSP 2 / ORFS 1 11/16 | CAT XSVGW NPT 2 / ORFS 1 11/16 |
| | 1 1/2" | 2"-12 | CAT XSVGW BSP 1 1/2 / ORFS 2 | CAT XSVGW NPT 1 1/2 / ORFS 2 |
| | 2" | 2"-12 | CAT XSVGW BSP 2 / ORFS 2 | CAT XSVGW NPT 2 / ORFS 2 |

CAT XESVG M / ORFS

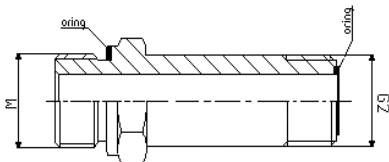

CAT XWESVG M / ORFS

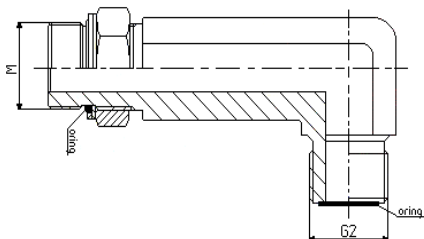

| Ciężnienie BAR | Gwint [M] | Gwint [G2] | Oznaczenie | |
|-------------------|--------------|---------------|---------------------------------|----------------------------------|
| | | | CAT XESVG M / ORFS | CAT XWESVG M / ORFS |
| 350 | 10x1 | 9/16"-18 | CAT XESVG M10x1 / ORFS 9/16 | CAT XWESVG M10x1 / ORFS 9/16 |
| 630 | 12x1,5 | 9/16"-18 | CAT XESVG M12x1,5 / ORFS 9/16 | CAT XWESVG M12x1,5 / ORFS 9/16 |
| | 12x1,5 | 11/16"-16 | CAT XESVG M12x1,5 / ORFS 11/16 | CAT XWESVG M12x1,5 / ORFS 11/16 |
| | 14x1,5 | 9/16"-18 | CAT XESVG M14x1,5 / ORFS 9/16 | CAT XWESVG M14x1,5 / ORFS 9/16 |
| | 14x1,5 | 11/16"-16 | CAT XESVG M14x1,5 / ORFS 11/16 | CAT XWESVG M14x1,5 / ORFS 11/16 |
| | 14x1,5 | 13/16"-16 | CAT XESVG M14x1,5 / ORFS 13/16 | CAT XWESVG M14x1,5 / ORFS 13/16 |
| | 16x1,5 | 11/16"-16 | CAT XESVG M16x1,5 / ORFS 11/16 | CAT XWESVG M16x1,5 / ORFS 11/16 |
| | 16x1,5 | 13/16"-16 | CAT XESVG M16x1,5 / ORFS 13/16 | CAT XWESVG M16x1,5 / ORFS 13/16 |
| | 18,1,5 | 11/16"-16 | CAT XESVG M18x1,5 / ORFS 11/16 | CAT XWESVG M18x1,5 / ORFS 11/16 |
| | 18x1,5 | 13/16"-16 | CAT XESVG M18x1,5 / ORFS 13/16 | CAT XWESVG M18x1,5 / ORFS 13/16 |
| | 18x1,5 | 1"-14 | CAT XESVG M18x1,5 / ORFS 1 | CAT XWESVG M18x1,5 / ORFS 1 |
| 420 | 22x1,5 | 11/16"-16 | CAT XESVG M22x1,5 / ORFS 11/16 | CAT XWESVG M22x1,5 / ORFS 11/16 |
| | 22x1,5 | 13/16"-16 | CAT XESVG M22x1,5 / ORFS 13/16 | CAT XWESVG M22x1,5 / ORFS 13/16 |
| | 22,1,5 | 1"-14 | CAT XESVG M22x1,5 / ORFS 1 | CAT XWESVG M22x1,5 / ORFS 1 |
| | 22x1,5 | 1 3/16"-12 | CAT XESVG M22x1,5 / ORFS 1 3/16 | CAT XWESVG M22x1,5 / ORFS 1 3/16 |
| | 27x2 | 1"-14 | CAT XESVG M27x2 / ORFS 1 | CAT XWESVG M27x2 / ORFS 1 |
| | 27x2 | 1 3/16"-12 | CAT XESVG M27x2 / ORFS 1 3/16 | CAT XWESVG M27x2 / ORFS 1 3/16 |
| | 27x2 | 1 7/16"-12 | CAT XESVG M27x2 / ORFS 1 7/16 | CAT XWESVG M27x2 / ORFS 1 7/16 |
| 280 | 33x2 | 1 3/16"-12 | CAT XESVG M33x2 / ORFS 1 3/16 | CAT XWESVG M33x2 / ORFS 1 3/16 |
| | 33x2 | 1 7/16"-12 | CAT XESVG M33x2 / ORFS 1 7/16 | CAT XWESVG M33x2 / ORFS 1 7/16 |
| | 33x2 | 1 11/16"-12 | CAT XESVG M33x2 / ORFS 1 11/16 | CAT XWESVG M33x2 / ORFS 1 11/16 |
| | 42x2 | 1 7/16"-12 | CAT XESVG M42x2 / ORFS 1 7/16 | CAT XWESVG M42x2 / ORFS 1 7/16 |
| | 42x2 | 1 11/16"-12 | CAT XESVG M42x2 / ORFS 1 11/16 | CAT XWESVG M42x2 / ORFS 1 11/16 |
| | 48x2 | 1 11/16"-12 | CAT XESVG M48x2 / ORFS 1 11/16 | CAT XWESVG M48x2 / ORFS 1 11/16 |
| | 48x2 | 2"-12 | CAT XESVG M48x2 / ORFS 2 | CAT XWESVG M48x2 / ORFS 2 |

ELEMENTY ZŁĄCZNE ORFS

CAT XESVG BSP / ORFS

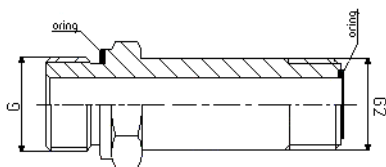

CAT XWESVG BSP / ORFS

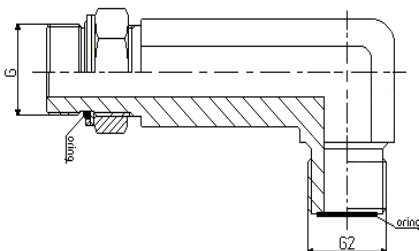

CAT XESVG UNF / ORFS

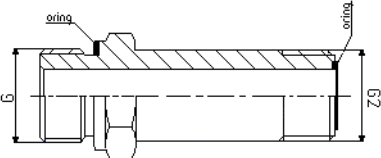

CAT XWESVG UNF / ORFS

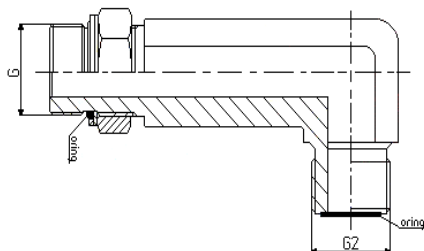

| Ciśnienie BAR | Gwint [G] | Gwint [G2] | Oznaczenie | |
|------------------|--------------|---------------|------------------------------------|-------------------------------------|
| | | | CAT XESVG BSP / ORFS | CAT XWESVG BSP / ORFS |
| 630 | 1/8" | 9/16"-18 | CAT XESVG BSP 1/8 / ORFS 9/16 | CAT XWESVG BSP 1/8 / ORFS 9/16 |
| | 1/8" | 11/16"-16 | CAT XESVG BSP 1/8 / ORFS 11/16 | CAT XWESVG BSP 1/8 / ORFS 11/16 |
| | 1/4" | 9/16"-18 | CAT XESVG BSP 1/4 / ORFS 9/16 | CAT XWESVG BSP 1/4 / ORFS 9/16 |
| | 1/4" | 11/16"-16 | CAT XESVG BSP 1/4 / ORFS 11/16 | CAT XWESVG BSP 1/4 / ORFS 11/16 |
| 420 | 1/4" | 13/16"-16 | CAT XESVG BSP 1/4 / ORFS 13/16 | CAT XWESVG BSP 1/4 / ORFS 13/16 |
| | 1/4" | 1"-14 | CAT XESVG BSP 1/4 / ORFS 1 | CAT XWESVG BSP 1/4 / ORFS 1 |
| | 1/4" | 1 3/16"-12 | CAT XESVG BSP 1/4 / ORFS 1 3/16 | CAT XWESVG BSP 1/4 / ORFS 1 3/16 |
| | 1/4" | 1 7/16"-12 | CAT XESVG BSP 1/4 / ORFS 1 7/16 | CAT XWESVG BSP 1/4 / ORFS 1 7/16 |
| 630 | 3/8" | 9/16"-18 | CAT XESVG BSP 3/8 / ORFS 9/16 | CAT XWESVG BSP 3/8 / ORFS 9/16 |
| | 3/8" | 11/16"-16 | CAT XESVG BSP 3/8 / ORFS 11/16 | CAT XWESVG BSP 3/8 / ORFS 11/16 |
| | 3/8" | 13/16"-16 | CAT XESVG BSP 3/8 / ORFS 13/16 | CAT XWESVG BSP 3/8 / ORFS 13/16 |
| | 3/8" | 1"-14 | CAT XESVG BSP 3/8 / ORFS 1 | CAT XWESVG BSP 3/8 / ORFS 1 |
| 420 | 3/8" | 1 3/16"-12 | CAT XESVG BSP 3/8 / ORFS 1 3/16 | CAT XWESVG BSP 3/8 / ORFS 1 3/16 |
| | 3/8" | 1 7/16"-12 | CAT XESVG BSP 3/8 / ORFS 1 7/16 | CAT XWESVG BSP 3/8 / ORFS 1 7/16 |
| | 1/2" | 9/16"-18 | CAT XESVG BSP 1/2 / ORFS 9/16 | CAT XWESVG BSP 1/2 / ORFS 9/16 |
| | 1/2" | 11/16"-16 | CAT XESVG BSP 1/2 / ORFS 11/16 | CAT XWESVG BSP 1/2 / ORFS 11/16 |
| 630 | 1/2" | 13/16"-16 | CAT XESVG BSP 1/2 / ORFS 13/16 | CAT XWESVG BSP 1/2 / ORFS 13/16 |
| | 1/2" | 1"-14 | CAT XESVG BSP 1/2 / ORFS 1 | CAT XWESVG BSP 1/2 / ORFS 1 |
| | 1/2" | 1 3/16"-12 | CAT XESVG BSP 1/2 / ORFS 1 3/16 | CAT XWESVG BSP 1/2 / ORFS 1 3/16 |
| | 1/2" | 1 7/16"-12 | CAT XESVG BSP 1/2 / ORFS 1 7/16 | CAT XWESVG BSP 1/2 / ORFS 1 7/16 |
| 420 | 3/4" | 11/16"-16 | CAT XESVG BSP 3/4 / ORFS 11/16 | CAT XWESVG BSP 3/4 / ORFS 11/16 |
| | 3/4" | 13/16"-16 | CAT XESVG BSP 3/4 / ORFS 13/16 | CAT XWESVG BSP 3/4 / ORFS 13/16 |
| | 3/4" | 1"-14 | CAT XESVG BSP 3/4 / ORFS 1 | CAT XWESVG BSP 3/4 / ORFS 1 |
| | 3/4" | 1 3/16"-12 | CAT XESVG BSP 3/4 / ORFS 1 3/16 | CAT XWESVG BSP 3/4 / ORFS 1 3/16 |
| | 3/4" | 1 7/16"-12 | CAT XESVG BSP 3/4 / ORFS 1 7/16 | CAT XWESVG BSP 3/4 / ORFS 1 7/16 |
| | 1" | 1"-14 | CAT XESVG BSP 1 / ORFS 1 | CAT XWESVG BSP 1 / ORFS 1 |
| | 1" | 1 3/16"-12 | CAT XESVG BSP 1 / ORFS 1 3/16 | CAT XWESVG BSP 1 / ORFS 1 3/16 |
| | 1" | 1 7/16"-12 | CAT XESVG BSP 1 / ORFS 1 7/16 | CAT XWESVG BSP 1 / ORFS 1 7/16 |
| | 1" | 1 11/16"-12 | CAT XESVG BSP 1 / ORFS 1 11/16 | CAT XWESVG BSP 1 / ORFS 1 11/16 |
| | 1" | 1 3/16"-12 | CAT XESVG BSP 1 / ORFS 1 3/16 | CAT XWESVG BSP 1 / ORFS 1 3/16 |
| 280 | 1 1/4" | 1 3/16"-12 | CAT XESVG BSP 1 1/4 / ORFS 1 3/16 | CAT XWESVG BSP 1 1/4 / ORFS 1 3/16 |
| | 1 1/4" | 1 7/16"-12 | CAT XESVG BSP 1 1/4 / ORFS 1 7/16 | CAT XWESVG BSP 1 1/4 / ORFS 1 7/16 |
| | 1 1/4" | 1 11/16"-12 | CAT XESVG BSP 1 1/4 / ORFS 1 11/16 | CAT XWESVG BSP 1 1/4 / ORFS 1 11/16 |
| | 1 1/2" | 1 7/16"-12 | CAT XESVG BSP 1 1/2 / ORFS 1 7/16 | CAT XWESVG BSP 1 1/2 / ORFS 1 7/16 |
| | 1 1/2" | 1 11/16"-12 | CAT XESVG BSP 1 1/2 / ORFS 1 11/16 | CAT XWESVG BSP 1 1/2 / ORFS 1 11/16 |
| | 1 1/2" | 2"-12 | CAT XESVG BSP 1 1/2 / ORFS 2 | CAT XWESVG BSP 1 1/2 / ORFS 2 |

| Ciśnienie BAR | Gwint [G] | Gwint [G2] | Oznaczenie | |
|------------------|--------------|---------------|------------------------------------|-------------------------------------|
| | | | CAT XESVG UNF / ORFS | CAT XWESVG UNF / ORFS |
| 630 | 7/16"-20 | 9/16"-18 | CAT XESVG UNF 7/16 / ORFS 9/16 | CAT XWESVG UNF 7/16 / ORFS 9/16 |
| | 7/16"-20 | 11/16"-16 | CAT XESVG UNF 7/16 / ORFS 11/16 | CAT XWESVG UNF 7/16 / ORFS 11/16 |
| | 1/2"-20 | 9/16"-18 | CAT XESVG UNF 1/2 / ORFS 9/16 | CAT XWESVG UNF 1/2 / ORFS 9/16 |
| | 1/2"-20 | 11/16"-16 | CAT XESVG UNF 1/2 / ORFS 11/16 | CAT XWESVG UNF 1/2 / ORFS 11/16 |
| | 9/16"-18 | 9/16"-18 | CAT XESVG UNF 9/16 / ORFS 9/16 | CAT XWESVG UNF 9/16 / ORFS 9/16 |
| | 9/16"-18 | 11/16"-16 | CAT XESVG UNF 9/16 / ORFS 11/16 | CAT XWESVG UNF 9/16 / ORFS 11/16 |
| | 9/16"-18 | 13/16"-16 | CAT XESVG UNF 9/16 / ORFS 13/16 | CAT XWESVG UNF 9/16 / ORFS 13/16 |
| | 3/4"-16 | 9/16"-18 | CAT XESVG UNF 3/4 / ORFS 9/16 | CAT XWESVG UNF 3/4 / ORFS 9/16 |
| | 3/4"-16 | 11/16"-16 | CAT XESVG UNF 3/4 / ORFS 11/16 | CAT XWESVG UNF 3/4 / ORFS 11/16 |
| | 3/4"-16 | 13/16"-16 | CAT XESVG UNF 3/4 / ORFS 13/16 | CAT XWESVG UNF 3/4 / ORFS 13/16 |
| 420 | 3/4"-16 | 1"-14 | CAT XESVG UNF 3/4 / ORFS 1 | CAT XWESVG UNF 3/4 / ORFS 1 |
| | 3/4"-16 | 1 3/16"-12 | CAT XESVG UNF 3/4 / ORFS 1 3/16 | CAT XWESVG UNF 3/4 / ORFS 1 3/16 |
| 630 | 7/8"-14 | 11/16"-16 | CAT XESVG UNF 7/8 / ORFS 11/16 | CAT XWESVG UNF 7/8 / ORFS 11/16 |
| | 7/8"-14 | 13/16"-16 | CAT XESVG UNF 7/8 / ORFS 13/16 | CAT XWESVG UNF 7/8 / ORFS 13/16 |
| 420 | 7/8"-14 | 1"-14 | CAT XESVG UNF 7/8 / ORFS 1 | CAT XWESVG UNF 7/8 / ORFS 1 |
| | 7/8"-14 | 1 3/16"-12 | CAT XESVG UNF 7/8 / ORFS 1 3/16 | CAT XWESVG UNF 7/8 / ORFS 1 3/16 |
| | 1 1/16"-12 | 11/16"-16 | CAT XESVG UNF 1 1/16 / ORFS 11/16 | CAT XWESVG UNF 1 1/16 / ORFS 11/16 |
| | 1 1/16"-12 | 13/16"-16 | CAT XESVG UNF 1 1/16 / ORFS 13/16 | CAT XWESVG UNF 1 1/16 / ORFS 13/16 |
| | 1 1/16"-12 | 1"-14 | CAT XESVG UNF 1 1/16 / ORFS 1 | CAT XWESVG UNF 1 1/16 / ORFS 1 |
| | 1 1/16"-12 | 1 3/16"-12 | CAT XESVG UNF 1 1/16 / ORFS 1 3/16 | CAT XWESVG UNF 1 1/16 / ORFS 1 3/16 |
| | 1 1/16"-12 | 1 7/16"-12 | CAT XESVG UNF 1 1/16 / ORFS 1 7/16 | CAT XWESVG UNF 1 1/16 / ORFS 1 7/16 |
| | 1 5/16"-12 | 13/16"-16 | CAT XESVG UNF 1 5/16 / ORFS 13/16 | CAT XWESVG UNF 1 5/16 / ORFS 13/16 |
| | 1 5/16"-12 | 1"-14 | CAT XESVG UNF 1 5/16 / ORFS 1 | CAT XWESVG UNF 1 5/16 / ORFS 1 |
| | 1 5/16"-12 | 1 3/16"-12 | CAT XESVG UNF 1 5/16 / ORFS 1 3/16 | CAT XWESVG UNF 1 5/16 / ORFS 1 3/16 |
| 280 | 1 5/16"-12 | 1 7/16"-12 | CAT XESVG UNF 1 5/16 / ORFS 1 7/16 | CAT XWESVG UNF 1 5/16 / ORFS 1 7/16 |
| | 1 5/8"-12 | 1 11/16"-12 | CAT XESVG UNF 1 5/8 / ORFS 1 11/16 | CAT XWESVG UNF 1 5/8 / ORFS 1 11/16 |
| | 1 5/8"-12 | 2"-12 | CAT XESVG UNF 1 5/8 / ORFS 2 | CAT XWESVG UNF 1 5/8 / ORFS 2 |
| | 1 7/8"-12 | 1 11/16"-12 | CAT XESVG UNF 1 7/8 / ORFS 1 11/16 | CAT XWESVG UNF 1 7/8 / ORFS 1 11/16 |
| | 1 7/8"-12 | 2"-12 | CAT XESVG UNF 1 7/8 / ORFS 2 | CAT XWESVG UNF 1 7/8 / ORFS 2 |
| | 1 7/8"-12 | 2"-12 | CAT XESVG UNF 1 7/8 / ORFS 2 | CAT XWESVG UNF 1 7/8 / ORFS 2 |

ELEMENTY ZŁĄCZNE ORFS

CAT XWE NPT / ORFS

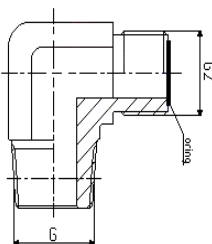

CAT 45 XWE NPT / ORFS

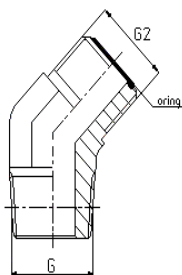

| Ciężnienie BAR | Gwint [G] | Gwint [G2] | Oznaczenie | |
|-------------------|--------------|---------------|----------------------------------|-------------------------------------|
| | | | CAT XWE NPT / ORFS | CAT 45 XWE NPT / ORFS |
| 630 | 1/8" | 9/16"-18 | CAT XWE NPT 1/8 / ORFS 9/16 | CAT 45 XWE NPT 1/8 / ORFS 9/16 |
| | 1/8" | 11/16"-16 | CAT XWE NPT 1/8 / ORFS 11/16 | CAT 45 XWE NPT 1/8 / ORFS 11/16 |
| | 1/4" | 9/16"-18 | CAT XWE NPT 1/4 / ORFS 9/16 | CAT 45 XWE NPT 1/4 / ORFS 9/16 |
| | 1/4" | 11/16"-16 | CAT XWE NPT 1/4 / ORFS 11/16 | CAT 45 XWE NPT 1/4 / ORFS 11/16 |
| 420 | 1/4" | 1"-14 | CAT XWE NPT 1/4 / ORFS 1 | CAT 45 XWE NPT 1/4 / ORFS 1 |
| | 1/4" | 1 3/16"-12 | CAT XWE NPT 1/4 / ORFS 1 3/16 | CAT 45 XWE NPT 1/4 / ORFS 1 3/16 |
| | 1/4" | 1 7/16"-12 | CAT XWE NPT 1/4 / ORFS 1 7/16 | CAT 45 XWE NPT 1/4 / ORFS 1 7/16 |
| 630 | 3/8" | 9/16"-18 | CAT XWE NPT 3/8 / ORFS 9/16 | CAT 45 XWE NPT 3/8 / ORFS 9/16 |
| | 3/8" | 11/16"-16 | CAT XWE NPT 3/8 / ORFS 11/16 | CAT 45 XWE NPT 3/8 / ORFS 11/16 |
| | 3/8" | 13/16"-16 | CAT XWE NPT 3/8 / ORFS 13/16 | CAT 45 XWE NPT 3/8 / ORFS 13/16 |
| 420 | 3/8" | 1"-14 | CAT XWE NPT 3/8 / ORFS 1 | CAT 45 XWE NPT 3/8 / ORFS 1 |
| | 3/8" | 1 3/16"-12 | CAT XWE NPT 3/8 / ORFS 1 3/16 | CAT 45 XWE NPT 3/8 / ORFS 1 3/16 |
| | 3/8" | 1 7/16"-12 | CAT XWE NPT 3/8 / ORFS 1 7/16 | CAT 45 XWE NPT 3/8 / ORFS 1 7/16 |
| 630 | 1/2" | 9/16"-18 | CAT XWE NPT 1/2 / ORFS 9/16 | CAT 45 XWE NPT 1/2 / ORFS 9/16 |
| | 1/2" | 11/16"-16 | CAT XWE NPT 1/2 / ORFS 11/16 | CAT 45 XWE NPT 1/2 / ORFS 11/16 |
| | 1/2" | 13/16"-16 | CAT XWE NPT 1/2 / ORFS 13/16 | CAT 45 XWE NPT 1/2 / ORFS 13/16 |
| 420 | 1/2" | 1"-14 | CAT XWE NPT 1/2 / ORFS 1 | CAT 45 XWE NPT 1/2 / ORFS 1 |
| | 1/2" | 1 3/16"-12 | CAT XWE NPT 1/2 / ORFS 1 3/16 | CAT 45 XWE NPT 1/2 / ORFS 1 3/16 |
| | 1/2" | 1 7/16"-12 | CAT XWE NPT 1/2 / ORFS 1 7/16 | CAT 45 XWE NPT 1/2 / ORFS 1 7/16 |
| | 3/4" | 11/16"-16 | CAT XWE NPT 3/4 / ORFS 11/16 | CAT 45 XWE NPT 3/4 / ORFS 11/16 |
| | 3/4" | 13/16"-16 | CAT XWE NPT 3/4 / ORFS 13/16 | CAT 45 XWE NPT 3/4 / ORFS 13/16 |
| | 3/4" | 1"-14 | CAT XWE NPT 3/4 / ORFS 1 | CAT 45 XWE NPT 3/4 / ORFS 1 |
| | 3/4" | 1 3/16"-12 | CAT XWE NPT 3/4 / ORFS 1 3/16 | CAT 45 XWE NPT 3/4 / ORFS 1 3/16 |
| | 3/4" | 1 7/16"-12 | CAT XWE NPT 3/4 / ORFS 1 7/16 | CAT 45 XWE NPT 3/4 / ORFS 1 7/16 |
| | 1" | 1"-14 | CAT XWE NPT 1 / ORFS 1 | CAT 45 XWE NPT 1 / ORFS 1 |
| | 1" | 1 3/16"-12 | CAT XWE NPT 1 / ORFS 1 3/16 | CAT 45 XWE NPT 1 / ORFS 1 3/16 |
| 280 | 1" | 1 7/16"-12 | CAT XWE NPT 1 / ORFS 1 7/16 | CAT 45 XWE NPT 1 / ORFS 1 7/16 |
| | 1" | 1 11/16"-12 | CAT XWE NPT 1 / ORFS 1 11/16 | CAT 45 XWE NPT 1 / ORFS 1 11/16 |
| | 1 1/4" | 1 3/16"-12 | CAT XWE NPT 1 1/4 / ORFS 1 3/16 | CAT 45 XWE NPT 1 1/4 / ORFS 1 3/16 |
| | 1 1/4" | 1 7/16"-12 | CAT XWE NPT 1 1/4 / ORFS 1 7/16 | CAT 45 XWE NPT 1 1/4 / ORFS 1 7/16 |
| | 1 1/4" | 1 11/16"-12 | CAT XWE NPT 1 1/4 / ORFS 1 11/16 | CAT 45 XWE NPT 1 1/4 / ORFS 1 11/16 |
| | 1 1/2" | 1 7/16"-12 | CAT XWE NPT 1 1/2 / ORFS 1 7/16 | CAT 45 XWE NPT 1 1/2 / ORFS 1 7/16 |
| | 1 1/2" | 1 11/16"-12 | CAT XWE NPT 1 1/2 / ORFS 1 11/16 | CAT 45 XWE NPT 1 1/2 / ORFS 1 11/16 |
| | 1 1/2" | 2"-12 | CAT XWE NPT 1 1/2 / ORFS 2 | CAT 45 XWE NPT 1 1/2 / ORFS 2 |

CAT XWEP M / ORFS

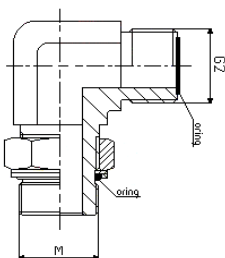

CAT 45 XWEP M / ORFS

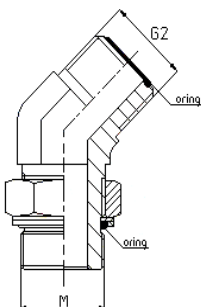

| Ciężnienie BAR | Gwint [M] | Gwint [G2] | Oznaczenie | |
|-------------------|--------------|---------------|--------------------------------|-----------------------------------|
| | | | CAT XWEP M / ORFS | CAT 45 XWEP M / ORFS |
| 350 | 10x1 | 9/16"-18 | CAT XWEP M10x1 / ORFS 9/16 | CAT 45 XWEP M10x1 / ORFS 9/16 |
| 630 | 12x1,5 | 9/16"-18 | CAT XWEP M12x1,5 / ORFS 9/16 | CAT 45 XWEP M12x1,5 / ORFS 9/16 |
| | 12x1,5 | 11/16"-16 | CAT XWEP M12x1,5 / ORFS 11/16 | CAT 45 XWEP M12x1,5 / ORFS 11/16 |
| | 14x1,5 | 9/16"-18 | CAT XWEP M14x1,5 / ORFS 9/16 | CAT 45 XWEP M14x1,5 / ORFS 9/16 |
| | 14x1,5 | 11/16"-16 | CAT XWEP M14x1,5 / ORFS 11/16 | CAT 45 XWEP M14x1,5 / ORFS 11/16 |
| | 14x1,5 | 13/16"-16 | CAT XWEP M14x1,5 / ORFS 13/16 | CAT 45 XWEP M14x1,5 / ORFS 13/16 |
| | 16x1,5 | 11/16"-16 | CAT XWEP M16x1,5 / ORFS 11/16 | CAT 45 XWEP M16x1,5 / ORFS 11/16 |
| | 16x1,5 | 13/16"-16 | CAT XWEP M16x1,5 / ORFS 13/16 | CAT 45 XWEP M16x1,5 / ORFS 13/16 |
| | 18,1,5 | 11/16"-16 | CAT XWEP M18x1,5 / ORFS 11/16 | CAT 45 XWEP M18x1,5 / ORFS 11/16 |
| | 18x1,5 | 13/16"-16 | CAT XWEP M18x1,5 / ORFS 13/16 | CAT 45 XWEP M18x1,5 / ORFS 13/16 |
| 420 | 18x1,5 | 1"-14 | CAT XWEP M18x1,5 / ORFS 1 | CAT 45 XWEP M18x1,5 / ORFS 1 |
| | 22x1,5 | 11/16"-16 | CAT XWEP M22x1,5 / ORFS 11/16 | CAT 45 XWEP M22x1,5 / ORFS 11/16 |
| | 22x1,5 | 13/16"-16 | CAT XWEP M22x1,5 / ORFS 13/16 | CAT 45 XWEP M22x1,5 / ORFS 13/16 |
| | 22,1,5 | 1"-14 | CAT XWEP M22x1,5 / ORFS 1 | CAT 45 XWEP M22x1,5 / ORFS 1 |
| | 22x1,5 | 1 3/16"-12 | CAT XWEP M22x1,5 / ORFS 1 3/16 | CAT 45 XWEP M22x1,5 / ORFS 1 3/16 |
| | 27x2 | 1"-14 | CAT XWEP M27x2 / ORFS 1 | CAT 45 XWEP M27x2 / ORFS 1 |
| | 27x2 | 1 3/16"-12 | CAT XWEP M27x2 / ORFS 1 3/16 | CAT 45 XWEP M27x2 / ORFS 1 3/16 |
| | 27x2 | 1 7/16"-12 | CAT XWEP M27x2 / ORFS 1 7/16 | CAT 45 XWEP M27x2 / ORFS 1 7/16 |
| | 33x2 | 1 3/16"-12 | CAT XWEP M33x2 / ORFS 1 3/16 | CAT 45 XWEP M33x2 / ORFS 1 3/16 |
| | 33x2 | 1 7/16"-12 | CAT XWEP M33x2 / ORFS 1 7/16 | CAT 45 XWEP M33x2 / ORFS 1 7/16 |
| 280 | 33x2 | 1 11/16"-12 | CAT XWEP M33x2 / ORFS 1 11/16 | CAT 45 XWEP M33x2 / ORFS 1 11/16 |
| | 42x2 | 1 7/16"-12 | CAT XWEP M42x2 / ORFS 1 7/16 | CAT 45 XWEP M42x2 / ORFS 1 7/16 |
| | 42x2 | 1 11/16"-12 | CAT XWEP M42x2 / ORFS 1 11/16 | CAT 45 XWEP M42x2 / ORFS 1 11/16 |
| | 48x2 | 1 11/16"-12 | CAT XWEP M48x2 / ORFS 1 11/16 | CAT 45 XWEP M48x2 / ORFS 1 11/16 |
| | 48x2 | 2"-12 | CAT XWEP M48x2 / ORFS 2 | CAT 45 XWEP M48x2 / ORFS 2 |

ELEMENTY ZŁĄCZNE ORFS

CAT XWEP BSP / ORFS

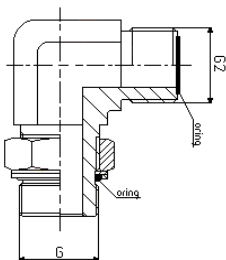

CAT 45 XWEP BSP / ORFS

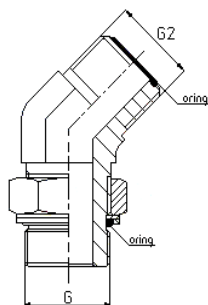

| Ciśnienie BAR | Gwint [G] | Gwint [G2] | Oznaczenie | |
|------------------|--------------|-----------------------------------|--------------------------------------|--------------------------------------|
| | | | CAT XWEP BSP / ORFS | CAT 45 XWEP BSP / ORFS |
| 630 | 1/8" | 9/16"-18 | CAT XWEP BSP 1/8 / ORFS 9/16 | CAT 45 XWEP BSP 1/8 / ORFS 9/16 |
| | 1/8" | 11/16"-16 | CAT XWEP BSP 1/8 / ORFS 11/16 | CAT 45 XWEP BSP 1/8 / ORFS 11/16 |
| | 1/4" | 9/16"-18 | CAT XWEP BSP 1/4 / ORFS 9/16 | CAT 45 XWEP BSP 1/4 / ORFS 9/16 |
| | 1/4" | 11/16"-16 | CAT XWEP BSP 1/4 / ORFS 11/16 | CAT 45 XWEP BSP 1/4 / ORFS 11/16 |
| 420 | 1/4" | 13/16"-16 | CAT XWEP BSP 1/4 / ORFS 13/16 | CAT 45 XWEP BSP 1/4 / ORFS 13/16 |
| | 1/4" | 1"-14 | CAT XWEP BSP 1/4 / ORFS 1 | CAT 45 XWEP BSP 1/4 / ORFS 1 |
| | 1/4" | 1 3/16"-12 | CAT XWEP BSP 1/4 / ORFS 1 3/16 | CAT 45 XWEP BSP 1/4 / ORFS 1 3/16 |
| 630 | 1/4" | 1 7/16"-12 | CAT XWEP BSP 1/4 / ORFS 1 7/16 | CAT 45 XWEP BSP 1/4 / ORFS 1 7/16 |
| | 3/8" | 9/16"-18 | CAT XWEP BSP 3/8 / ORFS 9/16 | CAT 45 XWEP BSP 3/8 / ORFS 9/16 |
| | 3/8" | 11/16"-16 | CAT XWEP BSP 3/8 / ORFS 11/16 | CAT 45 XWEP BSP 3/8 / ORFS 11/16 |
| 420 | 3/8" | 13/16"-16 | CAT XWEP BSP 3/8 / ORFS 13/16 | CAT 45 XWEP BSP 3/8 / ORFS 13/16 |
| | 3/8" | 1"-14 | CAT XWEP BSP 3/8 / ORFS 1 | CAT 45 XWEP BSP 3/8 / ORFS 1 |
| | 3/8" | 1 3/16"-12 | CAT XWEP BSP 3/8 / ORFS 1 3/16 | CAT 45 XWEP BSP 3/8 / ORFS 1 3/16 |
| 630 | 3/8" | 1 7/16"-12 | CAT XWEP BSP 3/8 / ORFS 1 7/16 | CAT 45 XWEP BSP 3/8 / ORFS 1 7/16 |
| | 1/2" | 9/16"-18 | CAT XWEP BSP 1/2 / ORFS 9/16 | CAT 45 XWEP BSP 1/2 / ORFS 9/16 |
| | 1/2" | 11/16"-16 | CAT XWEP BSP 1/2 / ORFS 11/16 | CAT 45 XWEP BSP 1/2 / ORFS 11/16 |
| | 1/2" | 13/16"-16 | CAT XWEP BSP 1/2 / ORFS 13/16 | CAT 45 XWEP BSP 1/2 / ORFS 13/16 |
| | 1/2" | 1"-14 | CAT XWEP BSP 1/2 / ORFS 1 | CAT 45 XWEP BSP 1/2 / ORFS 1 |
| | 1/2" | 1 3/16"-12 | CAT XWEP BSP 1/2 / ORFS 1 3/16 | CAT 45 XWEP BSP 1/2 / ORFS 1 3/16 |
| | 1/2" | 1 7/16"-12 | CAT XWEP BSP 1/2 / ORFS 1 7/16 | CAT 45 XWEP BSP 1/2 / ORFS 1 7/16 |
| | 3/4" | 11/16"-16 | CAT XWEP BSP 3/4 / ORFS 11/16 | CAT 45 XWEP BSP 3/4 / ORFS 11/16 |
| | 3/4" | 13/16"-16 | CAT XWEP BSP 3/4 / ORFS 13/16 | CAT 45 XWEP BSP 3/4 / ORFS 13/16 |
| | 3/4" | 1"-14 | CAT XWEP BSP 3/4 / ORFS 1 | CAT 45 XWEP BSP 3/4 / ORFS 1 |
| | 3/4" | 1 3/16"-12 | CAT XWEP BSP 3/4 / ORFS 1 3/16 | CAT 45 XWEP BSP 3/4 / ORFS 1 3/16 |
| | 3/4" | 1 7/16"-12 | CAT XWEP BSP 3/4 / ORFS 1 7/16 | CAT 45 XWEP BSP 3/4 / ORFS 1 7/16 |
| 280 | 1" | 1"-14 | CAT XWEP BSP 1 / ORFS 1 | CAT 45 XWEP BSP 1 / ORFS 1 |
| | 1" | 1 3/16"-12 | CAT XWEP BSP 1 / ORFS 1 3/16 | CAT 45 XWEP BSP 1 / ORFS 1 3/16 |
| | 1" | 1 7/16"-12 | CAT XWEP BSP 1 / ORFS 1 7/16 | CAT 45 XWEP BSP 1 / ORFS 1 7/16 |
| | 1" | 1 11/16"-12 | CAT XWEP BSP 1 / ORFS 1 11/16 | CAT 45 XWEP BSP 1 / ORFS 1 11/16 |
| | 1 1/4" | 1 3/16"-12 | CAT XWEP BSP 1 1/4 / ORFS 1 3/16 | CAT 45 XWEP BSP 1 1/4 / ORFS 1 3/16 |
| | 1 1/4" | 1 7/16"-12 | CAT XWEP BSP 1 1/4 / ORFS 1 7/16 | CAT 45 XWEP BSP 1 1/4 / ORFS 1 7/16 |
| | 1 1/4" | 1 11/16"-12 | CAT XWEP BSP 1 1/4 / ORFS 1 11/16 | CAT 45 XWEP BSP 1 1/4 / ORFS 1 11/16 |
| | 1 1/2" | 1 7/16"-12 | CAT XWEP BSP 1 1/2 / ORFS 1 7/16 | CAT 45 XWEP BSP 1 1/2 / ORFS 1 7/16 |
| 1 1/2" | 1 11/16"-12 | CAT XWEP BSP 1 1/2 / ORFS 1 11/16 | CAT 45 XWEP BSP 1 1/2 / ORFS 1 11/16 | |
| 1 1/2" | 2"-12 | CAT XWEP BSP 1 1/2 / ORFS 2 | CAT 45 XWEP BSP 1 1/2 / ORFS 2 | |

CAT XWEP UNF / ORFS

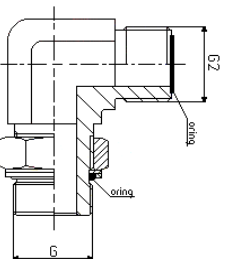

CAT 45 XWEP UNF / ORFS

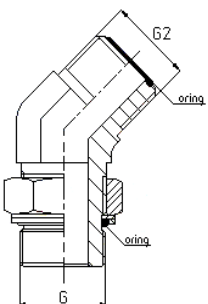

| Ciśnienie BAR | Gwint [G] | Gwint [G2] | Oznaczenie | |
|------------------|--------------|---------------|------------------------------------|---------------------------------------|
| | | | CAT XWEP UNF / ORFS | CAT 45 XWEP UNF / ORFS |
| 630 | 7/16"-20 | 9/16"-18 | CAT XWEP UNF 7/16 / ORFS 9/16 | CAT 45 XWEP UNF 7/16 / ORFS 9/16 |
| | 7/16"-20 | 11/16"-16 | CAT XWEP UNF 7/16 / ORFS 11/16 | CAT 45 XWEP UNF 7/16 / ORFS 11/16 |
| | 1/2"-20 | 9/16"-18 | CAT XWEP UNF 1/2 / ORFS 9/16 | CAT 45 XWEP UNF 1/2 / ORFS 9/16 |
| | 1/2"-20 | 11/16"-16 | CAT XWEP UNF 1/2 / ORFS 11/16 | CAT 45 XWEP UNF 1/2 / ORFS 11/16 |
| | 9/16"-18 | 9/16"-18 | CAT XWEP UNF 9/16 / ORFS 9/16 | CAT 45 XWEP UNF 9/16 / ORFS 9/16 |
| | 9/16"-18 | 11/16"-16 | CAT XWEP UNF 9/16 / ORFS 11/16 | CAT 45 XWEP UNF 9/16 / ORFS 11/16 |
| | 9/16"-18 | 13/16"-16 | CAT XWEP UNF 9/16 / ORFS 13/16 | CAT 45 XWEP UNF 9/16 / ORFS 13/16 |
| | 3/4"-16 | 9/16"-18 | CAT XWEP UNF 3/4 / ORFS 9/16 | CAT 45 XWEP UNF 3/4 / ORFS 9/16 |
| | 3/4"-16 | 11/16"-16 | CAT XWEP UNF 3/4 / ORFS 11/16 | CAT 45 XWEP UNF 3/4 / ORFS 11/16 |
| | 3/4"-16 | 13/16"-16 | CAT XWEP UNF 3/4 / ORFS 13/16 | CAT 45 XWEP UNF 3/4 / ORFS 13/16 |
| 420 | 3/4"-16 | 1"-14 | CAT XWEP UNF 3/4 / ORFS 1 | CAT 45 XWEP UNF 3/4 / ORFS 1 |
| | 3/4"-16 | 1 3/16"-12 | CAT XWEP UNF 3/4 / ORFS 1 3/16 | CAT 45 XWEP UNF 3/4 / ORFS 1 3/16 |
| 630 | 7/8"-14 | 11/16"-16 | CAT XWEP UNF 7/8 / ORFS 11/16 | CAT 45 XWEP UNF 7/8 / ORFS 11/16 |
| | 7/8"-14 | 13/16"-16 | CAT XWEP UNF 7/8 / ORFS 13/16 | CAT 45 XWEP UNF 7/8 / ORFS 13/16 |
| 420 | 7/8"-14 | 1"-14 | CAT XWEP UNF 7/8 / ORFS 1 | CAT 45 XWEP UNF 7/8 / ORFS 1 |
| | 7/8"-14 | 1 3/16"-12 | CAT XWEP UNF 7/8 / ORFS 1 3/16 | CAT 45 XWEP UNF 7/8 / ORFS 1 3/16 |
| | 1 1/16"-12 | 11/16"-16 | CAT XWEP UNF 1 1/16 / ORFS 11/16 | CAT 45 XWEP UNF 1 1/16 / ORFS 11/16 |
| | 1 1/16"-12 | 13/16"-16 | CAT XWEP UNF 1 1/16 / ORFS 13/16 | CAT 45 XWEP UNF 1 1/16 / ORFS 13/16 |
| | 1 1/16"-12 | 1"-14 | CAT XWEP UNF 1 1/16 / ORFS 1 | CAT 45 XWEP UNF 1 1/16 / ORFS 1 |
| | 1 1/16"-12 | 1 3/16"-12 | CAT XWEP UNF 1 1/16 / ORFS 1 3/16 | CAT 45 XWEP UNF 1 1/16 / ORFS 1 3/16 |
| | 1 1/16"-12 | 1 7/16"-12 | CAT XWEP UNF 1 1/16 / ORFS 1 7/16 | CAT 45 XWEP UNF 1 1/16 / ORFS 1 7/16 |
| | 1 5/16"-12 | 13/16"-16 | CAT XWEP UNF 1 5/16 / ORFS 13/16 | CAT 45 XWEP UNF 1 5/16 / ORFS 13/16 |
| | 1 5/16"-12 | 1"-14 | CAT XWEP UNF 1 5/16 / ORFS 1 | CAT 45 XWEP UNF 1 5/16 / ORFS 1 |
| | 1 5/16"-12 | 1 3/16"-12 | CAT XWEP UNF 1 5/16 / ORFS 1 3/16 | CAT 45 XWEP UNF 1 5/16 / ORFS 1 3/16 |
| | 1 5/16"-12 | 1 7/16"-12 | CAT XWEP UNF 1 5/16 / ORFS 1 7/16 | CAT 45 XWEP UNF 1 5/16 / ORFS 1 7/16 |
| | 1 5/16"-12 | 1 11/16"-12 | CAT XWEP UNF 1 5/16 / ORFS 1 11/16 | CAT 45 XWEP UNF 1 5/16 / ORFS 1 11/16 |
| 280 | 1 5/8"-12 | 1 7/16"-12 | CAT XWEP UNF 1 5/8 / ORFS 1 7/16 | CAT 45 XWEP UNF 1 5/8 / ORFS 1 7/16 |
| | 1 5/8"-12 | 1 11/16"-12 | CAT XWEP UNF 1 5/8 / ORFS 1 11/16 | CAT 45 XWEP UNF 1 5/8 / ORFS 1 11/16 |
| | 1 5/8"-12 | 2"-12 | CAT XWEP UNF 1 5/8 / ORFS 2 | CAT 45 XWEP UNF 1 5/8 / ORFS 2 |
| | 1 7/8"-12 | 1 11/16"-12 | CAT XWEP UNF 1 7/8 / ORFS 1 11/16 | CAT 45 XWEP UNF 1 7/8 / ORFS 1 11/16 |
| | 1 7/8"-12 | 2"-12 | CAT XWEP UNF 1 7/8 / ORFS 2 | CAT 45 XWEP UNF 1 7/8 / ORFS 2 |

ELEMENTY ZŁĄCZNE ORFS

CAT XELP M / ORFS

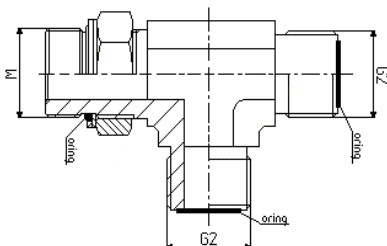

CAT XETP M / ORFS

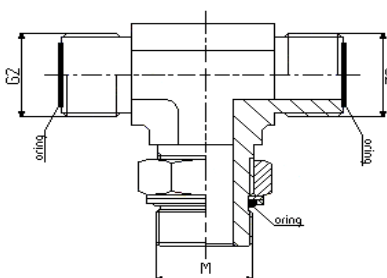

| Ciśnienie BAR | Gwint [M] | Gwint [G2] | Oznaczenie CAT XELP M / ORFS | Oznaczenie CAT XETP M / ORFS |
|------------------|--------------|---------------|---------------------------------|---------------------------------|
| 350 | 10x1 | 9/16"-18 | CAT XELP M10x1 / ORFS 9/16 | CAT XETP M10x1 / ORFS 9/16 |
| | 12x1,5 | 9/16"-18 | CAT XELP M12x1,5 / ORFS 9/16 | CAT XETP M12x1,5 / ORFS 9/16 |
| | 12x1,5 | 11/16"-16 | CAT XELP M12x1,5 / ORFS 11/16 | CAT XETP M12x1,5 / ORFS 11/16 |
| | 14x1,5 | 9/16"-18 | CAT XELP M14x1,5 / ORFS 9/16 | CAT XETP M14x1,5 / ORFS 9/16 |
| | 14x1,5 | 11/16"-16 | CAT XELP M14x1,5 / ORFS 11/16 | CAT XETP M14x1,5 / ORFS 11/16 |
| | 14x1,5 | 13/16"-16 | CAT XELP M14x1,5 / ORFS 13/16 | CAT XETP M14x1,5 / ORFS 13/16 |
| | 16x1,5 | 11/16"-16 | CAT XELP M16x1,5 / ORFS 11/16 | CAT XETP M16x1,5 / ORFS 11/16 |
| | 16x1,5 | 13/16"-16 | CAT XELP M16x1,5 / ORFS 13/16 | CAT XETP M16x1,5 / ORFS 13/16 |
| 630 | 18,1,5 | 11/16"-16 | CAT XELP M18x1,5 / ORFS 11/16 | CAT XETP M18x1,5 / ORFS 11/16 |
| | 18x1,5 | 13/16"-16 | CAT XELP M18x1,5 / ORFS 13/16 | CAT XETP M18x1,5 / ORFS 13/16 |
| | 18x1,5 | 1"-14 | CAT XELP M18x1,5 / ORFS 1 | CAT XETP M18x1,5 / ORFS 1 |
| | 22x1,5 | 11/16"-16 | CAT XELP M22x1,5 / ORFS 11/16 | CAT XETP M22x1,5 / ORFS 11/16 |
| | 22x1,5 | 13/16"-16 | CAT XELP M22x1,5 / ORFS 13/16 | CAT XETP M22x1,5 / ORFS 13/16 |
| | 22,1,5 | 1"-14 | CAT XELP M22x1,5 / ORFS 1 | CAT XETP M22x1,5 / ORFS 1 |
| | 22x1,5 | 1 3/16"-12 | CAT XELP M22x1,5 / ORFS 1 3/16 | CAT XETP M22x1,5 / ORFS 1 3/16 |
| | 27x2 | 1"-14 | CAT XELP M27x2 / ORFS 1 | CAT XETP M27x2 / ORFS 1 |
| | 27x2 | 1 3/16"-12 | CAT XELP M27x2 / ORFS 1 3/16 | CAT XETP M27x2 / ORFS 1 3/16 |
| | 27x2 | 1 7/16"-12 | CAT XELP M27x2 / ORFS 1 7/16 | CAT XETP M27x2 / ORFS 1 7/16 |
| 420 | 33x2 | 1 3/16"-12 | CAT XELP M33x2 / ORFS 1 3/16 | CAT XETP M33x2 / ORFS 1 3/16 |
| | 33x2 | 1 7/16"-12 | CAT XELP M33x2 / ORFS 1 7/16 | CAT XETP M33x2 / ORFS 1 7/16 |
| | 33x2 | 1 11/16"-12 | CAT XELP M33x2 / ORFS 1 7/16 | CAT XETP M33x2 / ORFS 1 7/16 |
| | 42x2 | 1 7/16"-12 | CAT XELP M42x2 / ORFS 1 7/16 | CAT XETP M42x2 / ORFS 1 7/16 |
| | 42x2 | 1 11/16"-12 | CAT XELP M42x2 / ORFS 1 11/16 | CAT XETP M42x2 / ORFS 1 11/16 |
| | 48x2 | 1 11/16"-12 | CAT XELP M48x2 / ORFS 1 11/16 | CAT XETP M48x2 / ORFS 1 11/16 |
| | 48x2 | 2"-12 | CAT XELP M48x2 / ORFS 2 | CAT XETP M48x2 / ORFS 2 |

CAT XELP BSP / ORFS

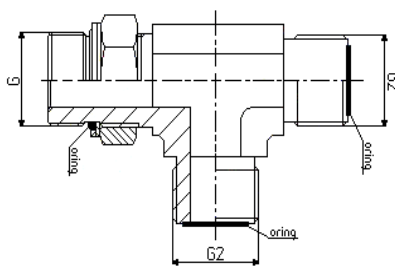

CAT XETP BSP / ORFS

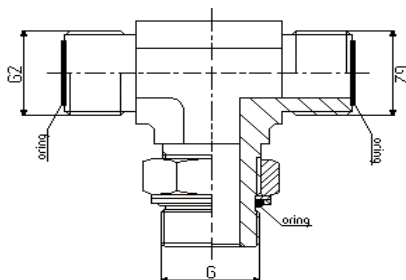

| Ciśnienie BAR | Gwint [G] | Gwint [G2] | Oznaczenie CAT XELP BSP / ORFS | Oznaczenie CAT XETP BSP / ORFS |
|------------------|--------------|---------------|-----------------------------------|-----------------------------------|
| 630 | 1/8" | 9/16"-18 | CAT XELP BSP 1/8 / ORFS 9/16 | CAT XETP BSP 1/8 / ORFS 9/16 |
| | 1/8" | 11/16"-16 | CAT XELP BSP 1/8 / ORFS 11/16 | CAT XETP BSP 1/8 / ORFS 11/16 |
| | 1/4" | 9/16"-18 | CAT XELP BSP 1/4 / ORFS 9/16 | CAT XETP BSP 1/4 / ORFS 9/16 |
| | 1/4" | 11/16"-16 | CAT XELP BSP 1/4 / ORFS 11/16 | CAT XETP BSP 1/4 / ORFS 11/16 |
| | 1/4" | 13/16"-16 | CAT XELP BSP 1/4 / ORFS 13/16 | CAT XETP BSP 1/4 / ORFS 13/16 |
| | 1/4" | 1"-14 | CAT XELP BSP 1/4 / ORFS 1 | CAT XETP BSP 1/4 / ORFS 1 |
| 420 | 1/4" | 1 3/16"-12 | CAT XELP BSP 1/4 / ORFS 1 3/16 | CAT XETP BSP 1/4 / ORFS 1 3/16 |
| | 1/4" | 1 7/16"-12 | CAT XELP BSP 1/4 / ORFS 1 7/16 | CAT XETP BSP 1/4 / ORFS 1 7/16 |
| | 3/8" | 9/16"-18 | CAT XELP BSP 3/8 / ORFS 9/16 | CAT XETP BSP 3/8 / ORFS 9/16 |
| | 3/8" | 11/16"-16 | CAT XELP BSP 3/8 / ORFS 11/16 | CAT XETP BSP 3/8 / ORFS 11/16 |
| 630 | 3/8" | 13/16"-16 | CAT XELP BSP 3/8 / ORFS 13/16 | CAT XETP BSP 3/8 / ORFS 13/16 |
| | 3/8" | 1"-14 | CAT XELP BSP 3/8 / ORFS 1 | CAT XETP BSP 3/8 / ORFS 1 |
| | 3/8" | 1 3/16"-12 | CAT XELP BSP 3/8 / ORFS 1 3/16 | CAT XETP BSP 3/8 / ORFS 1 3/16 |
| | 3/8" | 1 7/16"-12 | CAT XELP BSP 3/8 / ORFS 1 7/16 | CAT XETP BSP 3/8 / ORFS 1 7/16 |
| 630 | 1/2" | 9/16"-18 | CAT XELP BSP 1/2 / ORFS 9/16 | CAT XETP BSP 1/2 / ORFS 9/16 |
| | 1/2" | 11/16"-16 | CAT XELP BSP 1/2 / ORFS 11/16 | CAT XETP BSP 1/2 / ORFS 11/16 |
| | 1/2" | 13/16"-16 | CAT XELP BSP 1/2 / ORFS 13/16 | CAT XETP BSP 1/2 / ORFS 13/16 |
| 420 | 1/2" | 1"-14 | CAT XELP BSP 1/2 / ORFS 1 | CAT XETP BSP 1/2 / ORFS 1 |
| | 1/2" | 1 3/16"-12 | CAT XELP BSP 1/2 / ORFS 1 3/16 | CAT XETP BSP 1/2 / ORFS 1 3/16 |
| | 1/2" | 1 7/16"-12 | CAT XELP BSP 1/2 / ORFS 1 7/16 | CAT XETP BSP 1/2 / ORFS 1 7/16 |
| | 3/4" | 11/16"-16 | CAT XELP BSP 3/4 / ORFS 11/16 | CAT XETP BSP 3/4 / ORFS 11/16 |
| | 3/4" | 13/16"-16 | CAT XELP BSP 3/4 / ORFS 13/16 | CAT XETP BSP 3/4 / ORFS 13/16 |
| | 3/4" | 1"-14 | CAT XELP BSP 3/4 / ORFS 1 | CAT XETP BSP 3/4 / ORFS 1 |
| | 3/4" | 1 3/16"-12 | CAT XELP BSP 3/4 / ORFS 1 3/16 | CAT XETP BSP 3/4 / ORFS 1 3/16 |
| | 3/4" | 1 7/16"-12 | CAT XELP BSP 3/4 / ORFS 1 7/16 | CAT XETP BSP 3/4 / ORFS 1 7/16 |
| | 1" | 1"-14 | CAT XELP BSP 1 / ORFS 1 | CAT XETP BSP 1 / ORFS 1 |
| | 1" | 1 3/16"-12 | CAT XELP BSP 1 / ORFS 1 3/16 | CAT XETP BSP 1 / ORFS 1 3/16 |
| 280 | 1" | 1 7/16"-12 | CAT XELP BSP 1 / ORFS 1 7/16 | CAT XETP BSP 1 / ORFS 1 7/16 |
| | 1 1/4" | 1 11/16"-12 | CAT XELP BSP 1 1/4 / ORFS 1 11/16 | CAT XETP BSP 1 1/4 / ORFS 1 11/16 |
| | 1 1/4" | 1 3/16"-12 | CAT XELP BSP 1 1/4 / ORFS 1 3/16 | CAT XETP BSP 1 1/4 / ORFS 1 3/16 |
| | 1 1/4" | 1 7/16"-12 | CAT XELP BSP 1 1/4 / ORFS 1 7/16 | CAT XETP BSP 1 1/4 / ORFS 1 7/16 |
| | 1 1/2" | 1 7/16"-12 | CAT XELP BSP 1 1/2 / ORFS 1 7/16 | CAT XETP BSP 1 1/2 / ORFS 1 7/16 |
| | 1 1/2" | 1 11/16"-12 | CAT XELP BSP 1 1/2 / ORFS 1 11/16 | CAT XETP BSP 1 1/2 / ORFS 1 11/16 |

ELEMENTY ZŁĄCZNE ORFS

CAT XELP UNF / ORFS

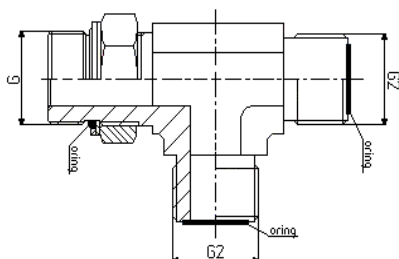

CAT XETP BSP / ORFS

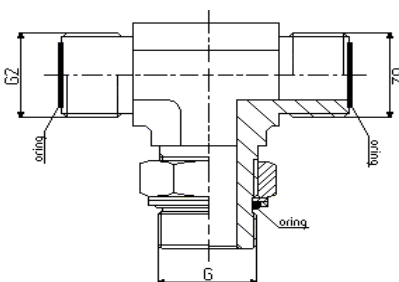

CAT XTP M / ORFS

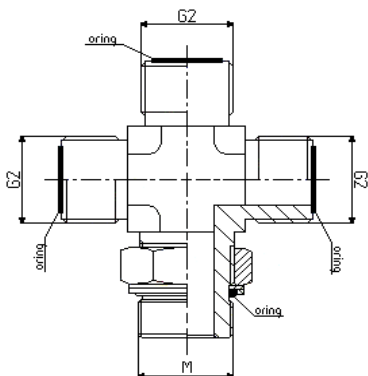

CAT XTP BSP / ORFS

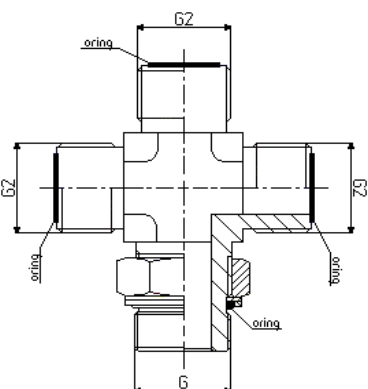

| Ciężnienie BAR | Gwint [G] | Gwint [G2] | Oznaczenie | |
|-------------------|--------------|---------------|-----------------------------------|-----------------------------------|
| | | | CAT XELP UNF / ORFS | CAT XETP UNF / ORFS |
| 630 | 7/16"-20 | 9/16"-18 | CAT XELP UNF 7/16 / ORFS 9/16 | CAT XETP UNF 7/16 / ORFS 9/16 |
| | 7/16"-20 | 11/16"-16 | CAT XELP UNF 7/16 / ORFS 11/16 | CAT XETP UNF 7/16 / ORFS 11/16 |
| | 1/2"-20 | 9/16"-18 | CAT XELP UNF 1/2 / ORFS 9/16 | CAT XETP UNF 1/2 / ORFS 9/16 |
| | 1/2"-20 | 11/16"-16 | CAT XELP UNF 1/2 / ORFS 11/16 | CAT XETP UNF 1/2 / ORFS 11/16 |
| | 9/16"-18 | 9/16"-18 | CAT XELP UNF 9/16 / ORFS 9/16 | CAT XETP UNF 9/16 / ORFS 9/16 |
| | 9/16"-18 | 11/16"-16 | CAT XELP UNF 9/16 / ORFS 11/16 | CAT XETP UNF 9/16 / ORFS 11/16 |
| | 9/16"-18 | 13/16"-16 | CAT XELP UNF 9/16 / ORFS 13/16 | CAT XETP UNF 9/16 / ORFS 13/16 |
| | 3/4"-16 | 9/16"-18 | CAT XELP UNF 3/4 / ORFS 9/16 | CAT XETP UNF 3/4 / ORFS 9/16 |
| | 3/4"-16 | 11/16"-16 | CAT XELP UNF 3/4 / ORFS 11/16 | CAT XETP UNF 3/4 / ORFS 11/16 |
| | 3/4"-16 | 13/16"-16 | CAT XELP UNF 3/4 / ORFS 13/16 | CAT XETP UNF 3/4 / ORFS 13/16 |
| 420 | 3/4"-16 | 1"-14 | CAT XELP UNF 3/4 / ORFS 1 | CAT XETP UNF 3/4 / ORFS 1 |
| | 3/4"-16 | 1 3/16"-12 | CAT XELP UNF 3/4 / ORFS 1 3/16 | CAT XETP UNF 3/4 / ORFS 1 3/16 |
| 630 | 7/8"-14 | 11/16"-16 | CAT XELP UNF 7/8 / ORFS 11/16 | CAT XETP UNF 7/8 / ORFS 11/16 |
| | 7/8"-14 | 13/16"-16 | CAT XELP UNF 7/8 / ORFS 13/16 | CAT XETP UNF 7/8 / ORFS 13/16 |
| 420 | 7/8"-14 | 1"-14 | CAT XELP UNF 7/8 / ORFS 1 | CAT XETP UNF 7/8 / ORFS 1 |
| | 7/8"-14 | 1 3/16"-12 | CAT XELP UNF 7/8 / ORFS 1 3/16 | CAT XETP UNF 7/8 / ORFS 1 3/16 |
| | 1 1/16"-12 | 11/16"-16 | CAT XELP UNF 1 1/16 / ORFS 11/16 | CAT XETP UNF 1 1/16 / ORFS 11/16 |
| | 1 1/16"-12 | 13/16"-16 | CAT XELP UNF 1 1/16 / ORFS 13/16 | CAT XETP UNF 1 1/16 / ORFS 13/16 |
| | 1 1/16"-12 | 1"-14 | CAT XELP UNF 1 1/16 / ORFS 1 | CAT XETP UNF 1 1/16 / ORFS 1 |
| | 1 1/16"-12 | 1 3/16"-12 | CAT XELP UNF 1 1/16 / ORFS 1 3/16 | CAT XETP UNF 1 1/16 / ORFS 1 3/16 |
| | 1 1/16"-12 | 1 7/16"-12 | CAT XELP UNF 1 1/16 / ORFS 1 7/16 | CAT XETP UNF 1 1/16 / ORFS 1 7/16 |
| | 1 5/16"-12 | 13/16"-16 | CAT XELP UNF 1 5/16 / ORFS 13/16 | CAT XETP UNF 1 5/16 / ORFS 13/16 |
| | 1 5/16"-12 | 1"-14 | CAT XELP UNF 1 5/16 / ORFS 1 | CAT XETP UNF 1 5/16 / ORFS 1 |
| | 1 5/16"-12 | 1 3/16"-12 | CAT XELP UNF 1 5/16 / ORFS 1 3/16 | CAT XETP UNF 1 5/16 / ORFS 1 3/16 |
| 280 | 1 5/16"-12 | 1 7/16"-12 | CAT XELP UNF 1 5/16 / ORFS 1 7/16 | CAT XETP UNF 1 5/16 / ORFS 1 7/16 |
| | 1 5/8"-12 | 1 11/16"-12 | CAT XELP UNF 1 5/8 / ORFS 1 11/16 | CAT XETP UNF 1 5/8 / ORFS 1 11/16 |
| | 1 5/8"-12 | 1 7/16"-12 | CAT XELP UNF 1 5/8 / ORFS 1 7/16 | CAT XETP UNF 1 5/8 / ORFS 1 7/16 |
| | 1 5/8"-12 | 2"-12 | CAT XELP UNF 1 5/8 / ORFS 2 | CAT XETP UNF 1 5/8 / ORFS 2 |
| | 1 7/8"-12 | 1 11/16"-12 | CAT XELP UNF 1 7/8 / ORFS 1 11/16 | CAT XETP UNF 1 7/8 / ORFS 1 11/16 |
| | 1 7/8"-12 | 2"-12 | CAT XELP UNF 1 7/8 / ORFS 2 | CAT XETP UNF 1 7/8 / ORFS 2 |

| Ciężnienie BAR | Gwint [M] | Gwint [G2] | Oznaczenie | |
|-------------------|--------------|---------------|------------------------------|--|
| | | | CAT XTP M / ORFS | |
| 315 | 12x1,5 | 9/16"-18 | CAT XTP M12x1,5 / ORFS 9/16 | |
| | 14x1,5 | 11/16"-16 | CAT XTP M14x1,5 / ORFS 11/16 | |
| | 18x1,5 | 13/16"-16 | CAT XTP M18x1,5 / ORFS 13/16 | |
| 250 | 22x1,5 | 1"-14 | CAT XTP M22x1,5 / ORFS 1 | |
| | 27x2 | 1 3/16"-12 | CAT XTP M27x2 / ORFS 1 3/16 | |
| 160 | 33x2 | 1 7/16"-12 | CAT XTP M33x2 / ORFS 1 7/16 | |
| | 42x2 | 1 11/16"-12 | CAT XTP M42x2 / ORFS 1 11/16 | |
| | 48x2 | 2"-12 | CAT XTP M48x2 / ORFS 2 | |

| Ciężnienie BAR | Gwint [G] | Gwint [G2] | Oznaczenie | |
|-------------------|--------------|---------------|----------------------------------|--|
| | | | CAT XTP BSP / ORFS | |
| 350 | 1/8" | 9/16"-18 | CAT XTP BSP 1/8 / ORFS 9/16 | |
| 315 | 1/4" | 11/16"-16 | CAT XTP BSP 1/4 / ORFS 11/16 | |
| | 3/8" | 13/16"-16 | CAT XTP BSP 3/8 / ORFS 13/16 | |
| 250 | 1/2" | 1"-14 | CAT XTP BSP 1/2 / ORFS 1 | |
| | 3/4" | 1 3/16"-12 | CAT XTP BSP 3/4 / ORFS 1 3/16 | |
| 200 | 1" | 1 7/16"-12 | CAT XTP BSP 1 / ORFS 1 7/16 | |
| | 1 1/4" | 1 11/16"-12 | CAT XTP BSP 1 1/4 / ORFS 1 11/16 | |
| 160 | 1 1/2" | 2"-12 | CAT XTP BSP 1 1/2 / ORFS 2 | |

ELEMENTY ZŁĄCZNE ORFS

CAT XTP UNF / ORFS

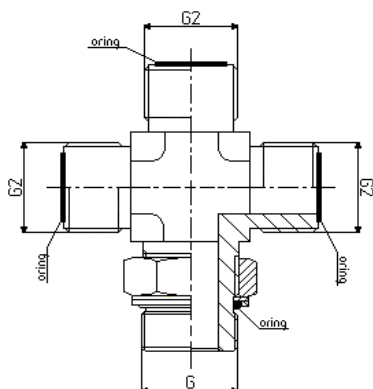

| Ciśnienie BAR | Gwint [G] | Gwint [G2] | Oznaczenie CAT XTP UNF / ORFS |
|------------------|--------------|---------------|---|
| 420 | 7/16"-20 | 9/16"-18 | CAT XTP UNF 7/16 / ORFS 9/16 |
| | 9/16"-18 | 11/16"-16 | CAT XTP UNF 9/16 / ORFS 11/16 |
| | 3/4"-16 | 13/16"-16 | CAT XTP UNF 3/4 / ORFS 13/16 |
| | 7/8"-14 | 1"-14 | CAT XTP UNF 7/8 / ORFS 1 |
| | 1 1/16"-12 | 1 3/16"-12 | CAT XTP UNF 1 1/16 / ORFS 1 3/16 |
| 380 | 1 5/16"-12 | 1 7/16"-12 | CAT XTP UNF 1 5/16 / ORFS 1 7/16 |
| 280 | 1 5/8"-12 | 1 11/16"-12 | CAT XTP UNF 1 5/8 / ORFS 1 11/16 |
| | 1 7/8"-12 | 2"-12 | CAT XTP UNF 1 7/8 / ORFS 2 |

CAT XEWP M / ORFS

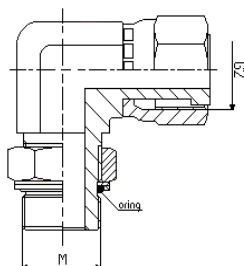

| Ciśnienie BAR | Gwint [M] | Gwint [G2] | Oznaczenie CAT XEWP M / ORFS |
|------------------|--------------|---------------|--|
| 350 | 10x1 | 9/16"-18 | CAT XEWP M10x1 / ORFS 9/16 |
| 630 | 12x1,5 | 9/16"-18 | CAT XEWP M12x1,5 / ORFS 9/16 |
| | 12x1,5 | 11/16"-16 | CAT XEWP M12x1,5 / ORFS 11/16 |
| | 14x1,5 | 9/16"-18 | CAT XEWP M14x1,5 / ORFS 9/16 |
| | 14x1,5 | 11/16"-16 | CAT XEWP M14x1,5 / ORFS 11/16 |
| | 14x1,5 | 13/16"-16 | CAT XEWP M14x1,5 / ORFS 13/16 |
| | 16x1,5 | 11/16"-16 | CAT XEWP M16x1,5 / ORFS 11/16 |
| | 16x1,5 | 13/16"-16 | CAT XEWP M16x1,5 / ORFS 13/16 |
| | 18,1,5 | 11/16"-16 | CAT XEWP M18x1,5 / ORFS 11/16 |
| 420 | 18x1,5 | 13/16"-16 | CAT XEWP M18x1,5 / ORFS 13/16 |
| | 18x1,5 | 1"-14 | CAT XEWP M18x1,5 / ORFS 1 |
| | 22x1,5 | 11/16"-16 | CAT XEWP M22x1,5 / ORFS 11/16 |
| | 22x1,5 | 13/16"-16 | CAT XEWP M22x1,5 / ORFS 13/16 |
| | 22,1,5 | 1"-14 | CAT XEWP M22x1,5 / ORFS 1 |
| | 22x1,5 | 1 3/16"-12 | CAT XEWP M22x1,5 / ORFS 1 3/16 |
| | 27x2 | 1"-14 | CAT XEWP M27x2 / ORFS 1 |
| | 27x2 | 1 3/16"-12 | CAT XEWP M27x2 / ORFS 1 3/16 |
| | 27x2 | 1 7/16"-12 | CAT XEWP M27x2 / ORFS 1 7/16 |
| | 33x2 | 1 3/16"-12 | CAT XEWP M33x2 / ORFS 1 3/16 |
| 280 | 33x2 | 1 7/16"-12 | CAT XEWP M33x2 / ORFS 1 7/16 |
| | 33x2 | 1 11/16"-12 | CAT XEWP M33x2 / ORFS 1 7/16 |
| | 42x2 | 1 7/16"-12 | CAT XEWP M42x2 / ORFS 1 7/16 |
| | 42x2 | 1 11/16"-12 | CAT XEWP M42x2 / ORFS 1 11/16 |
| | 48x2 | 1 11/16"-12 | CAT XEWP M48x2 / ORFS 1 11/16 |
| | 48x2 | 2"-12 | CAT XEWP M48x2 / ORFS 2 |

ELEMENTY ZŁĄCZNE ORFS

CAT XEWP BSP / ORFS

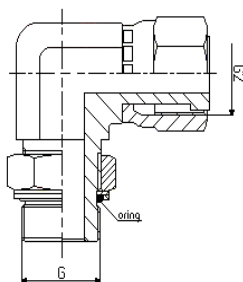

| Ciśnienie BAR | Gwint [G] | Gwint [G2] | Oznaczenie CAT XEWP BSP / ORFS |
|------------------|--------------|---------------|--|
| 630 | 1/8" | 9/16"-18 | CAT XEWP BSP 1/8 / ORFS 9/16 |
| | 1/8" | 11/16"-16 | CAT XEWP BSP 1/8 / ORFS 11/16 |
| | 1/4" | 9/16"-18 | CAT XEWP BSP 1/4 / ORFS 9/16 |
| | 1/4" | 11/16"-16 | CAT XEWP BSP 1/4 / ORFS 11/16 |
| 420 | 1/4" | 13/16"-16 | CAT XEWP BSP 1/4 / ORFS 13/16 |
| | 1/4" | 1"-14 | CAT XEWP BSP 1/4 / ORFS 1 |
| | 1/4" | 1 3/16"-12 | CAT XEWP BSP 1/4 / ORFS 1 3/16 |
| 630 | 1/4" | 1 7/16"-12 | CAT XEWP BSP 1/4 / ORFS 1 7/16 |
| | 3/8" | 9/16"-18 | CAT XEWP BSP 3/8 / ORFS 9/16 |
| | 3/8" | 11/16"-16 | CAT XEWP BSP 3/8 / ORFS 11/16 |
| 420 | 3/8" | 13/16"-16 | CAT XEWP BSP 3/8 / ORFS 13/16 |
| | 3/8" | 1"-14 | CAT XEWP BSP 3/8 / ORFS 1 |
| | 3/8" | 1 3/16"-12 | CAT XEWP BSP 3/8 / ORFS 1 3/16 |
| 630 | 3/8" | 1 7/16"-12 | CAT XEWP BSP 3/8 / ORFS 1 7/16 |
| | 1/2" | 9/16"-18 | CAT XEWP BSP 1/2 / ORFS 9/16 |
| | 1/2" | 11/16"-16 | CAT XEWP BSP 1/2 / ORFS 11/16 |
| 420 | 1/2" | 13/16"-16 | CAT XEWP BSP 1/2 / ORFS 13/16 |
| | 1/2" | 1"-14 | CAT XEWP BSP 1/2 / ORFS 1 |
| | 1/2" | 1 3/16"-12 | CAT XEWP BSP 1/2 / ORFS 1 3/16 |
| | 1/2" | 1 7/16"-12 | CAT XEWP BSP 1/2 / ORFS 1 7/16 |
| | 3/4" | 11/16"-16 | CAT XEWP BSP 3/4 / ORFS 11/16 |
| | 3/4" | 13/16"-16 | CAT XEWP BSP 3/4 / ORFS 13/16 |
| | 3/4" | 1"-14 | CAT XEWP BSP 3/4 / ORFS 1 |
| | 3/4" | 1 3/16"-12 | CAT XEWP BSP 3/4 / ORFS 1 3/16 |
| | 3/4" | 1 7/16"-12 | CAT XEWP BSP 3/4 / ORFS 1 7/16 |
| | 1" | 1"-14 | CAT XEWP BSP 1 / ORFS 1 |
| 280 | 1" | 1 3/16"-12 | CAT XEWP BSP 1 / ORFS 1 3/16 |
| | 1" | 1 7/16"-12 | CAT XEWP BSP 1 / ORFS 1 7/16 |
| | 1 1/4" | 1 11/16"-12 | CAT XEWP BSP 1 1/4 / ORFS 1 11/16 |
| | 1 1/4" | 1 3/16"-12 | CAT XEWP BSP 1 1/4 / ORFS 1 3/16 |
| | 1 1/4" | 1 7/16"-12 | CAT XEWP BSP 1 1/4 / ORFS 1 7/16 |
| | 1 1/2" | 1 7/16"-12 | CAT XEWP BSP 1 1/2 / ORFS 1 7/16 |
| | 1 1/2" | 1 11/16"-12 | CAT XEWP BSP 1 1/2 / ORFS 1 11/16 |
| | 1 1/2" | 2"-12 | CAT XEWP BSP 1 1/2 / ORFS 2 |

CAT XEWP UNF / ORFS

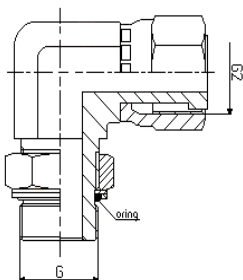

| Ciśnienie BAR | Gwint [G] | Gwint [G2] | Oznaczenie CAT XEWP UNF / ORFS |
|------------------|--------------|---------------|--|
| 630 | 7/16"-20 | 9/16"-18 | CAT XEWP UNF 7/16 / ORFS 9/16 |
| | 7/16"-20 | 11/16"-16 | CAT XEWP UNF 7/16 / ORFS 11/16 |
| | 1/2"-20 | 9/16"-18 | CAT XEWP UNF 1/2 / ORFS 9/16 |
| | 1/2"-20 | 11/16"-16 | CAT XEWP UNF 1/2 / ORFS 11/16 |
| | 9/16"-18 | 9/16"-18 | CAT XEWP UNF 9/16 / ORFS 9/16 |
| | 9/16"-18 | 11/16"-16 | CAT XEWP UNF 9/16 / ORFS 11/16 |
| | 9/16"-18 | 13/16"-16 | CAT XEWP UNF 9/16 / ORFS 13/16 |
| | 3/4"-16 | 9/16"-18 | CAT XEWP UNF 3/4 / ORFS 9/16 |
| | 3/4"-16 | 11/16"-16 | CAT XEWP UNF 3/4 / ORFS 11/16 |
| | 3/4"-16 | 13/16"-16 | CAT XEWP UNF 3/4 / ORFS 13/16 |
| 420 | 3/4"-16 | 1"-14 | CAT XEWP UNF 3/4 / ORFS 1 |
| | 3/4"-16 | 1 3/16"-12 | CAT XEWP UNF 3/4 / ORFS 1 3/16 |
| 630 | 7/8"-14 | 11/16"-16 | CAT XEWP UNF 7/8 / ORFS 11/16 |
| | 7/8"-14 | 13/16"-16 | CAT XEWP UNF 7/8 / ORFS 13/16 |
| 420 | 7/8"-14 | 1"-14 | CAT XEWP UNF 7/8 / ORFS 1 |
| | 7/8"-14 | 1 3/16"-12 | CAT XEWP UNF 7/8 / ORFS 1 3/16 |
| | 1 1/16"-12 | 11/16"-16 | CAT XEWP UNF 1 1/16 / ORFS 11/16 |
| | 1 1/16"-12 | 13/16"-16 | CAT XEWP UNF 1 1/16 / ORFS 13/16 |
| | 1 1/16"-12 | 1"-14 | CAT XEWP UNF 1 1/16 / ORFS 1 |
| | 1 1/16"-12 | 1 3/16"-12 | CAT XEWP UNF 1 1/16 / ORFS 1 3/16 |
| | 1 1/16"-12 | 1 7/16"-12 | CAT XEWP UNF 1 1/16 / ORFS 1 7/16 |
| | 1 5/16"-12 | 13/16"-16 | CAT XEWP UNF 1 5/16 / ORFS 13/16 |
| | 1 5/16"-12 | 1"-14 | CAT XEWP UNF 1 5/16 / ORFS 1 |
| | 1 5/16"-12 | 1 3/16"-12 | CAT XEWP UNF 1 5/16 / ORFS 1 3/16 |
| 280 | 1 5/16"-12 | 1 7/16"-12 | CAT XEWP UNF 1 5/16 / ORFS 1 7/16 |
| | 1 5/8"-12 | 1 11/16"-12 | CAT XEWP UNF 1 5/8 / ORFS 1 11/16 |
| | 1 5/8"-12 | 2"-12 | CAT XEWP UNF 1 5/8 / ORFS 2 |
| | 1 7/8"-12 | 1 11/16"-12 | CAT XEWP UNF 1 7/8 / ORFS 1 11/16 |
| | 1 7/8"-12 | 2"-12 | CAT XEWP UNF 1 7/8 / ORFS 2 |
| | | 1 7/8"-12 | 2"-12 |

ELEMENTY ZŁĄCZNE ORFS

CAT XG ORFS / ORFS

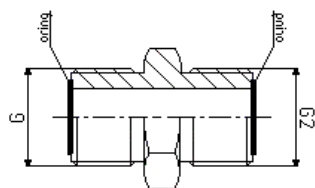

CAT XGR ORFS / ORFS

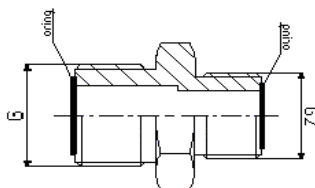

CAT XW ORFS / ORFS

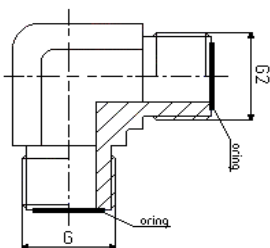

CAT XWR ORFS / ORFS

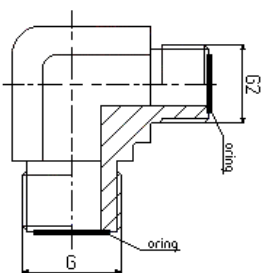

CAT 45 XW ORFS / ORFS

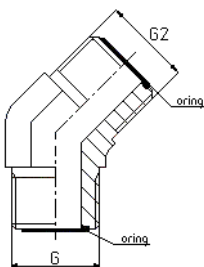

| Ciśnienie BAR | Gwint [G] | Gwint [G2] | Oznaczenie | |
|------------------|--------------|---------------|------------------------------------|------------------------------------|
| | | | CAT XG ORFS / ORFS | CAT XGR ORFS / ORFS |
| 630 | 9/16"-18 | 9/16"-18 | CAT XG ORFS 9/16 / ORFS 9/16 | |
| | 11/16"-16 | 9/16"-18 | | CAT XGR ORFS 11/16 / ORFS 9/16 |
| | 13/16"-16 | 9/16"-18 | | CAT XGR ORFS 13/16 / ORFS 9/16 |
| | 11/16"-16 | 11/16"-16 | CAT XG ORFS 11/16 / ORFS 11/16 | |
| 420 | 13/16"-16 | 11/16"-16 | | CAT XGR ORFS 13/16 / ORFS 11/16 |
| | 1"-14 | 11/16"-16 | | CAT XGR ORFS 1 / ORFS 11/16 |
| 630 | 13/16"-16 | 13/16"-16 | CAT XG ORFS 13/16 / ORFS 13/16 | |
| 420 | 1"-14 | 13/16"-16 | | CAT XGR ORFS 1 / ORFS 13/16 |
| | 1 3/16"-12 | 13/16"-16 | | CAT XGR ORFS 1 3/16 / ORFS 13/16 |
| | 1"-14 | 1"-14 | CAT XG ORFS 1 / ORFS 1 | |
| | 1 3/16"-12 | 1"-14 | | CAT XGR ORFS 1 3/16 / ORFS 1 |
| | 1 7/16"-12 | 1"-14 | | CAT XGR ORFS 1 7/16 / ORFS 1 |
| | 1 3/16"-12 | 1 3/16"-12 | CAT XG ORFS 1 3/16 / ORFS 1 3/16 | |
| 280 | 1 7/16"-12 | 1 3/16"-12 | | CAT XGR ORFS 1 7/16 / ORFS 1 3/16 |
| | 1 11/16"-12 | 1 3/16"-12 | | |
| 420 | 1 7/16"-12 | 1 7/16"-12 | CAT XG ORFS 1 7/16 / ORFS 1 7/16 | |
| 280 | 1 11/16"-12 | 1 7/16"-12 | | CAT XGR ORFS 1 11/16 / ORFS 1 7/16 |
| | 2"-12 | 1 7/16"-12 | | CAT XGR ORFS 2 / ORFS 1 7/16 |
| | 1 11/16"-12 | 1 11/16"-12 | CAT XG ORFS 1 11/16 / ORFS 1 11/16 | |
| | 2"-12 | 1 11/16"-12 | | CAT XGR ORFS 2 / ORFS 1 11/16 |
| | 2"-12 | 2"-12 | CAT XG ORFS 2 / ORFS 2 | |

| Ciśnienie BAR | Gwint [G] | Gwint [G2] | Oznaczenie | |
|------------------|--------------|---------------|------------------------------------|------------------------------------|
| | | | CAT XW ORFS / ORFS | CAT XWR ORFS / ORFS |
| 630 | 9/16"-18 | 9/16"-18 | CAT XW ORFS 9/16 / ORFS 9/16 | |
| | 11/16"-16 | 9/16"-18 | | CAT XWR ORFS 11/16 / ORFS 9/16 |
| | 13/16"-16 | 9/16"-18 | | CAT XWR ORFS 13/16 / ORFS 9/16 |
| | 11/16"-16 | 11/16"-16 | CAT XW ORFS 11/16 / ORFS 11/16 | |
| 420 | 13/16"-16 | 11/16"-16 | | CAT XWR ORFS 13/16 / ORFS 11/16 |
| | 1"-14 | 11/16"-16 | | CAT XWR ORFS 1 / ORFS 11/16 |
| 630 | 13/16"-16 | 13/16"-16 | CAT XW ORFS 13/16 / ORFS 13/16 | |
| 420 | 1"-14 | 13/16"-16 | | CAT XWR ORFS 1 / ORFS 13/16 |
| | 1 3/16"-12 | 13/16"-16 | | CAT XWR ORFS 1 3/16 / ORFS 13/16 |
| | 1"-14 | 1"-14 | CAT XW ORFS 1 / ORFS 1 | |
| | 1 3/16"-12 | 1"-14 | | CAT XWR ORFS 1 3/16 / ORFS 1 |
| | 1 7/16"-12 | 1"-14 | | CAT XWR ORFS 1 7/16 / ORFS 1 |
| | 1 3/16"-12 | 1 3/16"-12 | CAT XW ORFS 1 3/16 / ORFS 1 3/16 | |
| 280 | 1 7/16"-12 | 1 3/16"-12 | | CAT XWR ORFS 1 7/16 / ORFS 1 3/16 |
| | 1 11/16"-12 | 1 3/16"-12 | | |
| 420 | 1 7/16"-12 | 1 7/16"-12 | CAT XW ORFS 1 7/16 / ORFS 1 7/16 | |
| 280 | 1 11/16"-12 | 1 7/16"-12 | | CAT XWR ORFS 1 11/16 / ORFS 1 7/16 |
| | 2"-12 | 1 7/16"-12 | | CAT XWR ORFS 2 / ORFS 1 7/16 |
| | 1 11/16"-12 | 1 11/16"-12 | CAT XW ORFS 1 11/16 / ORFS 1 11/16 | |
| | 2"-12 | 1 11/16"-12 | | CAT XWR ORFS 2 / ORFS 1 11/16 |
| | 2"-12 | 2"-12 | CAT XW ORFS 2 / ORFS 2 | |

| Ciśnienie BAR | Gwint [G] | Gwint [G2] | Oznaczenie | |
|------------------|--------------|---------------|---------------------------------------|--|
| | | | CAT 45 XW ORFS / ORFS | |
| 630 | 9/16"-18 | 9/16"-18 | CAT 45 XW ORFS 9/16 / ORFS 9/16 | |
| | 11/16"-16 | 11/16"-16 | CAT 45 XW ORFS 11/16 / ORFS 11/16 | |
| | 13/16"-16 | 13/16"-16 | CAT 45 XW ORFS 13/16 / ORFS 13/16 | |
| 420 | 1"-14 | 1"-14 | CAT 45 XW ORFS 1 / ORFS 1 | |
| | 1 3/16"-12 | 1 3/16"-12 | CAT 45 XW ORFS 1 3/16 / ORFS 1 3/16 | |
| | 1 7/16"-12 | 1 7/16"-12 | CAT 45 XW ORFS 1 7/16 / ORFS 1 7/16 | |
| 280 | 1 11/16"-12 | 1 11/16"-12 | CAT 45 XW ORFS 1 11/16 / ORFS 1 11/16 | |
| | 2"-12 | 2"-12 | CAT 45 XW ORFS 2 / ORFS 2 | |

ELEMENTY ZŁĄCZNE ORFS

CAT XT ORFS / ORFS

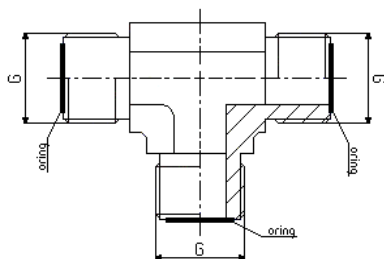

| Ciężnienie BAR | Gwint [G] | Oznaczenie |
|-------------------|--------------|------------------------------------|
| | | CAT XT ORFS / ORFS |
| 630 | 9/16"-18 | CAT XT ORFS 9/16 / ORFS 9/16 |
| | 11/16"-16 | CAT XT ORFS 11/16 / ORFS 11/16 |
| | 13/16"-16 | CAT XT ORFS 13/16 / ORFS 13/16 |
| 420 | 1"-14 | CAT XT ORFS 1 / ORFS 1 |
| | 1 3/16"-12 | CAT XT ORFS 1 3/16 / ORFS 1 3/16 |
| | 1 7/16"-12 | CAT XT ORFS 1 7/16 / ORFS 1 7/16 |
| 280 | 1 11/16"-12 | CAT XT ORFS 1 11/16 / ORFS 1 11/16 |
| | 2"-12 | CAT XT ORFS 2 / ORFS 2 |

CAT XK ORFS / ORFS

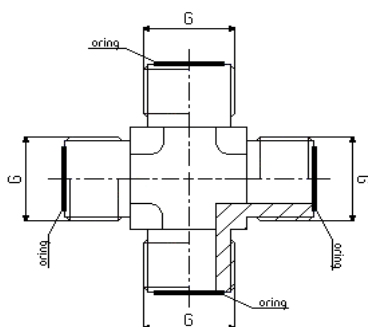

| Ciężnienie BAR | Gwint [G] | Oznaczenie |
|-------------------|--------------|------------------------------------|
| | | CAT XK ORFS / ORFS |
| 630 | 9/16"-18 | CAT XK ORFS 9/16 / ORFS 9/16 |
| | 11/16"-16 | CAT XK ORFS 11/16 / ORFS 11/16 |
| | 13/16"-16 | CAT XK ORFS 13/16 / ORFS 13/16 |
| 420 | 1"-14 | CAT XK ORFS 1 / ORFS 1 |
| | 1 3/16"-12 | CAT XK ORFS 1 3/16 / ORFS 1 3/16 |
| | 1 7/16"-12 | CAT XK ORFS 1 7/16 / ORFS 1 7/16 |
| 280 | 1 11/16"-12 | CAT XK ORFS 1 11/16 / ORFS 1 11/16 |
| | 2"-12 | CAT XK ORFS 2 / ORFS 2 |

CAT XSV ORFS / ORFS

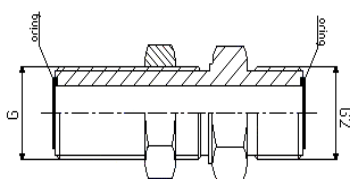

| Ciężnienie BAR | Gwint [G] | Gwint [G2] | Oznaczenie |
|-------------------|--------------|---------------|-------------------------------------|
| | | | CAT XSV ORFS / ORFS |
| 630 | 9/16"-18 | 9/16"-18 | CAT XSV ORFS 9/16 / ORFS 9/16 |
| | 11/16"-16 | 11/16"-16 | CAT XSV ORFS 11/16 / ORFS 11/16 |
| | 13/16"-16 | 13/16"-16 | CAT XSV ORFS 13/16 / ORFS 13/16 |
| 420 | 1"-14 | 1"-14 | CAT XSV ORFS 1 / ORFS 1 |
| | 1 3/16"-12 | 1 3/16"-12 | CAT XSV ORFS 1 3/16 / ORFS 1 3/16 |
| | 1 7/16"-12 | 1 7/16"-12 | CAT XSV ORFS 1 7/16 / ORFS 1 7/16 |
| 280 | 1 11/16"-12 | 1 11/16"-12 | CAT XSV ORFS 1 11/16 / ORFS 1 11/16 |
| | 2"-12 | 2"-12 | CAT XSV ORFS 2 / ORFS 2 |

CAT XWSV ORFS / ORFS

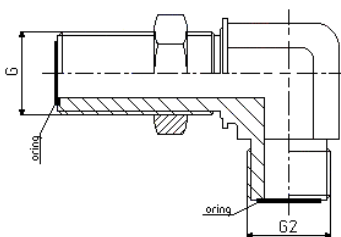

| Ciężnienie BAR | Gwint [G] | Gwint [G2] | Oznaczenie |
|-------------------|--------------|---------------|--------------------------------------|
| | | | CAT XWSV ORFS / ORFS |
| 630 | 9/16"-18 | 9/16"-18 | CAT XWSV ORFS 9/16 / ORFS 9/16 |
| | 11/16"-16 | 11/16"-16 | CAT XWSV ORFS 11/16 / ORFS 11/16 |
| | 13/16"-16 | 13/16"-16 | CAT XWSV ORFS 13/16 / ORFS 13/16 |
| 420 | 1"-14 | 1"-14 | CAT XWSV ORFS 1 / ORFS 1 |
| | 1 3/16"-12 | 1 3/16"-12 | CAT XWSV ORFS 1 3/16 / ORFS 1 3/16 |
| | 1 7/16"-12 | 1 7/16"-12 | CAT XWSV ORFS 1 7/16 / ORFS 1 7/16 |
| 280 | 1 11/16"-12 | 1 11/16"-12 | CAT XWSV ORFS 1 11/16 / ORFS 1 11/16 |
| | 2"-12 | 2"-12 | CAT XWSV ORFS 2 / ORFS 2 |

CAT 45 XWSV ORFS / ORFS

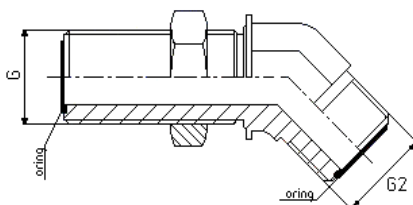

| Ciężnienie BAR | Gwint [G] | Gwint [G2] | Oznaczenie |
|-------------------|--------------|---------------|---|
| | | | CAT 45 XWSV ORFS / ORFS |
| 630 | 9/16"-18 | 9/16"-18 | CAT 45 XWSV ORFS 9/16 / ORFS 9/16 |
| | 11/16"-16 | 11/16"-16 | CAT 45 XWSV ORFS 11/16 / ORFS 11/16 |
| | 13/16"-16 | 13/16"-16 | CAT 45 XWSV ORFS 13/16 / ORFS 13/16 |
| 420 | 1"-14 | 1"-14 | CAT 45 XWSV ORFS 1 / ORFS 1 |
| | 1 3/16"-12 | 1 3/16"-12 | CAT 45 XWSV ORFS 1 3/16 / ORFS 1 3/16 |
| | 1 7/16"-12 | 1 7/16"-12 | CAT 45 XWSV ORFS 1 7/16 / ORFS 1 7/16 |
| 280 | 1 11/16"-12 | 1 11/16"-12 | CAT 45 XWSV ORFS 1 11/16 / ORFS 1 11/16 |
| | 2"-12 | 2"-12 | CAT 45 XWSV ORFS 2 / ORFS 2 |

ELEMENTY ZŁĄCZNE ORFS

CAT XTELP ORFS / ORFS

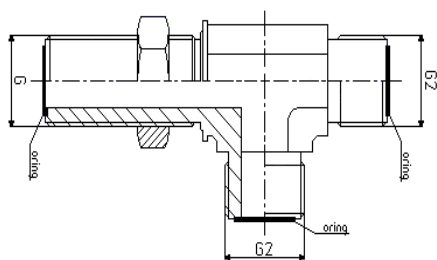

| Ciśnienie BAR | Gwint [G] | Gwint [G2] | Oznaczenie |
|------------------|--------------|---------------|---------------------------------------|
| | | | CAT XTELP ORFS / ORFS |
| 630 | 9/16"-18 | 9/16"-18 | CAT XTELP ORFS 9/16 / ORFS 9/16 |
| | 11/16"-16 | 11/16"-16 | CAT XTELP ORFS 11/16 / ORFS 11/16 |
| | 13/16"-16 | 13/16"-16 | CAT XTELP ORFS 13/16 / ORFS 13/16 |
| 420 | 1"-14 | 1"-14 | CAT XTELP ORFS 1 / ORFS 1 |
| | 1 3/16"-12 | 1 3/16"-12 | CAT XTELP ORFS 1 3/16 / ORFS 1 3/16 |
| | 1 7/16"-12 | 1 7/16"-12 | CAT XTELP ORFS 1 7/16 / ORFS 1 7/16 |
| 280 | 1 11/16"-12 | 1 11/16"-12 | CAT XTELP ORFS 1 11/16 / ORFS 1 11/16 |
| | 2"-12 | 2"-12 | CAT XTELP ORFS 2 / ORFS 2 |

CAT XTETP ORFS / ORFS

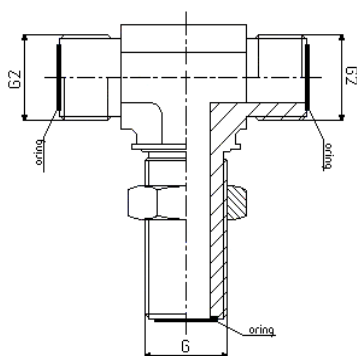

| Ciśnienie BAR | Gwint [G] | Gwint [G2] | Oznaczenie |
|------------------|--------------|---------------|---------------------------------------|
| | | | CAT XTETP ORFS / ORFS |
| 630 | 9/16"-18 | 9/16"-18 | CAT XTETP ORFS 9/16 / ORFS 9/16 |
| | 11/16"-16 | 11/16"-16 | CAT XTETP ORFS 11/16 / ORFS 11/16 |
| | 13/16"-16 | 13/16"-16 | CAT XTETP ORFS 13/16 / ORFS 13/16 |
| 420 | 1"-14 | 1"-14 | CAT XTETP ORFS 1 / ORFS 1 |
| | 1 3/16"-12 | 1 3/16"-12 | CAT XTETP ORFS 1 3/16 / ORFS 1 3/16 |
| | 1 7/16"-12 | 1 7/16"-12 | CAT XTETP ORFS 1 7/16 / ORFS 1 7/16 |
| 280 | 1 11/16"-12 | 1 11/16"-12 | CAT XTETP ORFS 1 11/16 / ORFS 1 11/16 |
| | 2"-12 | 2"-12 | CAT XTETP ORFS 2 / ORFS 2 |

CAT XEW ORFS / ORFS

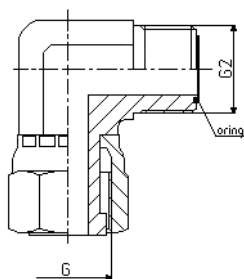

| Ciśnienie BAR | Gwint [G] | Gwint [G2] | Oznaczenie |
|------------------|--------------|---------------|-------------------------------------|
| | | | CAT XEW ORFS / ORFS |
| 630 | 9/16"-18 | 9/16"-18 | CAT XEW ORFS 9/16 / ORFS 9/16 |
| | 11/16"-16 | 11/16"-16 | CAT XEW ORFS 11/16 / ORFS 11/16 |
| | 13/16"-16 | 13/16"-16 | CAT XEW ORFS 13/16 / ORFS 13/16 |
| 420 | 1"-14 | 1"-14 | CAT XEW ORFS 1 / ORFS 1 |
| | 1 3/16"-12 | 1 3/16"-12 | CAT XEW ORFS 1 3/16 / ORFS 1 3/16 |
| | 1 7/16"-12 | 1 7/16"-12 | CAT XEW ORFS 1 7/16 / ORFS 1 7/16 |
| 280 | 1 11/16"-12 | 1 11/16"-12 | CAT XEW ORFS 1 11/16 / ORFS 1 11/16 |
| | 2"-12 | 2"-12 | CAT XEW ORFS 2 / ORFS 2 |

CAT 45 XEW ORFS / ORFS

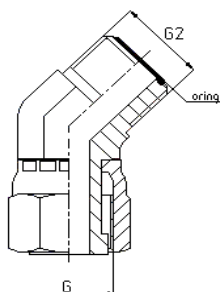

| Ciśnienie BAR | Gwint [G] | Gwint [G2] | Oznaczenie |
|------------------|--------------|---------------|--|
| | | | CAT 45 XEW ORFS / ORFS |
| 630 | 9/16"-18 | 9/16"-18 | CAT 45 XEW ORFS 9/16 / ORFS 9/16 |
| | 11/16"-16 | 11/16"-16 | CAT 45 XEW ORFS 11/16 / ORFS 11/16 |
| | 13/16"-16 | 13/16"-16 | CAT 45 XEW ORFS 13/16 / ORFS 13/16 |
| 420 | 1"-14 | 1"-14 | CAT 45 XEW ORFS 1 / ORFS 1 |
| | 1 3/16"-12 | 1 3/16"-12 | CAT 45 XEW ORFS 1 3/16 / ORFS 1 3/16 |
| | 1 7/16"-12 | 1 7/16"-12 | CAT 45 XEW ORFS 1 7/16 / ORFS 1 7/16 |
| 280 | 1 11/16"-12 | 1 11/16"-12 | CAT 45 XEW ORFS 1 11/16 / ORFS 1 11/16 |
| | 2"-12 | 2"-12 | CAT 45 XEW ORFS 2 / ORFS 2 |

ELEMENTY ZŁĄCZNE ORFS

CAT XEL ORFS / ORFS

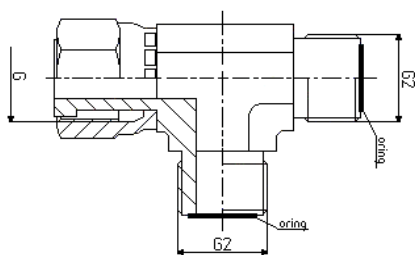

| Ciśnienie BAR | Gwint [G] | Gwint [G2] | Oznaczenie CAT XEL ORFS / ORFS |
|------------------|--------------|---------------|--|
| 630 | 9/16"-18 | 9/16"-18 | CAT XEL ORFS 9/16 / ORFS 9/16 |
| | 11/16"-16 | 11/16"-16 | CAT XEL ORFS 11/16 / ORFS 11/16 |
| | 13/16"-16 | 13/16"-16 | CAT XEL ORFS 13/16 / ORFS 13/16 |
| 420 | 1"-14 | 1"-14 | CAT XEL ORFS 1 / ORFS 1 |
| | 1 3/16"-12 | 1 3/16"-12 | CAT XEL ORFS 1 3/16 / ORFS 1 3/16 |
| | 1 7/16"-12 | 1 7/16"-12 | CAT XEL ORFS 1 7/16 / ORFS 1 7/16 |
| 280 | 1 11/16"-12 | 1 11/16"-12 | CAT XEL ORFS 1 11/16 / ORFS 1 11/16 |
| | 2"-12 | 2"-12 | CAT XEL ORFS 2 / ORFS 2 |

CAT XET ORFS / ORFS

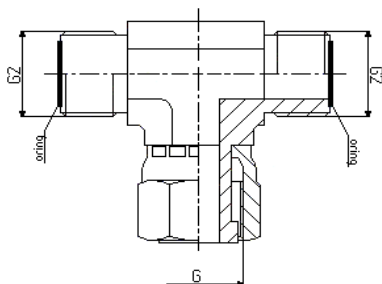

| Ciśnienie BAR | Gwint [G] | Gwint [G2] | Oznaczenie CAT XET ORFS / ORFS |
|------------------|--------------|---------------|--|
| 630 | 9/16"-18 | 9/16"-18 | CAT XET ORFS 9/16 / ORFS 9/16 |
| | 11/16"-16 | 11/16"-16 | CAT XET ORFS 11/16 / ORFS 11/16 |
| | 13/16"-16 | 13/16"-16 | CAT XET ORFS 13/16 / ORFS 13/16 |
| 420 | 1"-14 | 1"-14 | CAT XET ORFS 1 / ORFS 1 |
| | 1 3/16"-12 | 1 3/16"-12 | CAT XET ORFS 1 3/16 / ORFS 1 3/16 |
| | 1 7/16"-12 | 1 7/16"-12 | CAT XET ORFS 1 7/16 / ORFS 1 7/16 |
| 280 | 1 11/16"-12 | 1 11/16"-12 | CAT XET ORFS 1 11/16 / ORFS 1 11/16 |
| | 2"-12 | 2"-12 | CAT XET ORFS 2 / ORFS 2 |

CAT XMAV BSP / ORFS

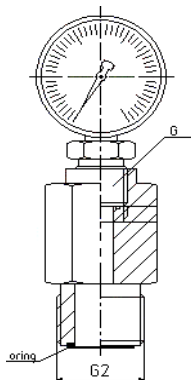

| Ciśnienie BAR | Gwint [G] | Gwint [G2] | Oznaczenie CAT XMAV BSP / ORFS |
|------------------|--------------|---------------|--|
| 630 | 1/4" | 9/16"-18 | CAT XMAV BSP 1/4 / ORFS 9/16 |
| | 1/4" | 11/16"-16 | CAT XMAV BSP 1/4 / ORFS 11/16 |
| | 1/4" | 13/16"-16 | CAT XMAV BSP 1/4 / ORFS 13/16 |
| 630 | 1/2" | 9/16"-18 | CAT XMAV BSP 1/2 / ORFS 9/16 |
| | 1/2" | 11/16"-16 | CAT XMAV BSP 1/2 / ORFS 11/16 |
| | 1/2" | 13/16"-16 | CAT XMAV BSP 1/2 / ORFS 13/16 |

CAT MAV-EV BSP / ORFS

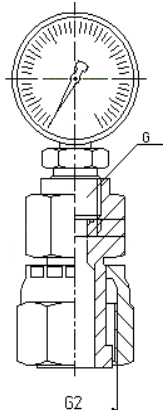

| Ciśnienie BAR | Gwint [G] | Gwint [G2] | Oznaczenie CAT MAV-EV BSP / ORFS |
|------------------|--------------|---------------|--|
| 630 | 1/4" | 9/16"-18 | CAT MAV-EV 1/4 / ORFS 9/16 |
| | 1/4" | 11/16"-16 | CAT MAV-EV 1/4 / ORFS 11/16 |
| | 1/4" | 13/16"-16 | CAT MAV-EV 1/4 / ORFS 13/16 |
| 420 | 1/4" | 1"-14 | CAT MAV-EV 1/4 / ORFS 1 |
| | 1/4" | 1 3/16"-12 | CAT MAV-EV 1/4 / ORFS 1 3/16 |
| | 1/4" | 1 7/16"-12 | CAT MAV-EV 1/4 / ORFS 1 7/16 |
| 280 | 1/4" | 1 11/16"-12 | CAT MAV-EV 1/4 / ORFS 1 11/16 |
| | 1/4" | 2"-12 | CAT MAV-EV 1/4 / ORFS 2 |

| Ciśnienie BAR | Gwint [G] | Gwint [G2] | Oznaczenie CAT MAV-EV BSP / ORFS |
|------------------|--------------|---------------|--|
| 630 | 1/2" | 9/16"-18 | CAT MAV-EV 1/2 / ORFS 9/16 |
| | 1/2" | 11/16"-16 | CAT MAV-EV 1/2 / ORFS 11/16 |
| | 1/2" | 13/16"-16 | CAT MAV-EV 1/2 / ORFS 13/16 |
| 420 | 1/2" | 1"-14 | CAT MAV-EV 1/2 / ORFS 1 |
| | 1/2" | 1 3/16"-12 | CAT MAV-EV 1/2 / ORFS 1 3/16 |
| | 1/2" | 1 7/16"-12 | CAT MAV-EV 1/2 / ORFS 1 7/16 |
| 280 | 1/2" | 1 11/16"-12 | CAT MAV-EV 1/2 / ORFS 1 11/16 |
| | 1/2" | 2"-12 | CAT MAV-EV 1/2 / ORFS 2 |

ELEMENTY ZŁĄCZNE ORFS

CAT GZ ORFS / ORFS

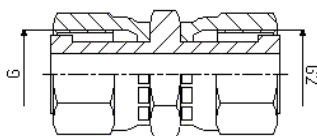

| Ciśnienie BAR | Gwint [G] | Gwint [G2] | Oznaczenie CAT GZ ORFS / ORFS |
|------------------|--------------|---------------|---|
| 630 | 9/16"-18 | 9/16"-18 | CAT GZ ORFS 9/16 / ORFS 9/16 |
| | 11/16"-16 | 11/16"-16 | CAT GZ ORFS 11/16 / ORFS 11/16 |
| | 13/16"-16 | 13/16"-16 | CAT GZ ORFS 13/16 / ORFS 13/16 |
| 420 | 1"-14 | 1"-14 | CAT GZ ORFS 1 / ORFS 1 |
| | 1 3/16"-12 | 1 3/16"-12 | CAT GZ ORFS 1 3/16 / ORFS 1 3/16 |
| | 1 7/16"-12 | 1 7/16"-12 | CAT GZ ORFS 1 7/16 / ORFS 1 7/16 |
| 280 | 1 11/16"-12 | 1 11/16"-12 | CAT GZ ORFS 1 11/16 / ORFS 1 11/16 |
| | 2"-12 | 2"-12 | CAT GZ ORFS 2 / ORFS 2 |

CAT GM ORFS / ORFS

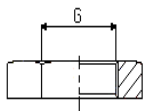

| Ciśnienie BAR | Gwint [G] | Oznaczenie CAT GM ORFS / ORFS |
|------------------|--------------|---|
| 630 | 9/16"-18 | CAT GM ORFS 9/16 / ORFS 9/16 |
| | 11/16"-16 | CAT GM ORFS 11/16 / ORFS 11/16 |
| | 13/16"-16 | CAT GM ORFS 13/16 / ORFS 13/16 |
| 420 | 1"-14 | CAT GM ORFS 1 / ORFS 1 |
| | 1 3/16"-12 | CAT GM ORFS 1 3/16 / ORFS 1 3/16 |
| | 1 7/16"-12 | CAT GM ORFS 1 7/16 / ORFS 1 7/16 |
| 280 | 1 11/16"-12 | CAT GM ORFS 1 11/16 / ORFS 1 11/16 |
| | 2"-12 | CAT GM ORFS 2 / ORFS 2 |

CAT VKA ORFS / ORFS

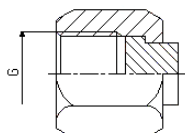

| Ciśnienie BAR | Gwint [G] | Oznaczenie CAT VKA ORFS / ORFS |
|------------------|--------------|--|
| 630 | 9/16"-18 | CAT VKA ORFS 9/16 / ORFS 9/16 |
| | 11/16"-16 | CAT VKA ORFS 11/16 / ORFS 11/16 |
| | 13/16"-16 | CAT VKA ORFS 13/16 / ORFS 13/16 |
| 420 | 1"-14 | CAT VKA ORFS 1 / ORFS 1 |
| | 1 3/16"-12 | CAT VKA ORFS 1 3/16 / ORFS 1 3/16 |
| | 1 7/16"-12 | CAT VKA ORFS 1 7/16 / ORFS 1 7/16 |
| 280 | 1 11/16"-12 | CAT VKA ORFS 1 11/16 / ORFS 1 11/16 |
| | 2"-12 | CAT VKA ORFS 2 / ORFS 2 |

CAT XROV ORFS / ORFS

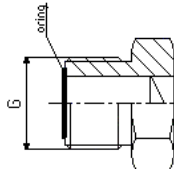

| Ciśnienie BAR | Gwint [G] | Oznaczenie CAT XROV ORFS / ORFS |
|------------------|--------------|---|
| 630 | 9/16"-18 | CAT XROV ORFS 9/16 / ORFS 9/16 |
| | 11/16"-16 | CAT XROV ORFS 11/16 / ORFS 11/16 |
| | 13/16"-16 | CAT XROV ORFS 13/16 / ORFS 13/16 |
| 420 | 1"-14 | CAT XROV ORFS 1 / ORFS 1 |
| | 1 3/16"-12 | CAT XROV ORFS 1 3/16 / ORFS 1 3/16 |
| | 1 7/16"-12 | CAT XROV ORFS 1 7/16 / ORFS 1 7/16 |
| 280 | 1 11/16"-12 | CAT XROV ORFS 1 11/16 / ORFS 1 11/16 |
| | 2"-12 | CAT XROV ORFS 2 / ORFS 2 |

CAT SKA

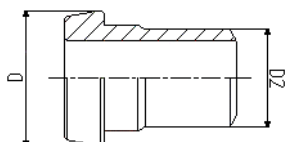

| Ciśnienie BAR | [D] | [D2] | Oznaczenie CAT SKA |
|------------------|-------|------|------------------------------|
| 630 | 12,75 | 6 | CAT SKA 6 |
| | 15,75 | 8 | CAT SKA 8 |
| | 15,75 | 10 | CAT SKA 10 |
| | 18,9 | 12 | CAT SKA 12 |
| 420 | 23,45 | 14 | CAT SKA 14 |
| | 23,45 | 15 | CAT SKA 15 |
| | 23,45 | 16 | CAT SKA 16 |
| | 17,85 | 18 | CAT SKA 18 |
| | 17,85 | 20 | CAT SKA 20 |
| | 34,2 | 22 | CAT SKA 22 |
| 280 | 34,2 | 25 | CAT SKA 25 |
| | 40,55 | 28 | CAT SKA 28 |
| | 40,55 | 30 | CAT SKA 30 |
| | 40,55 | 32 | CAT SKA 32 |
| | 48,5 | 35 | CAT SKA 35 |
| | 48,5 | 38 | CAT SKA 38 |

ELEMENTY ZŁĄCZNE ORFS

CAT XROVS ORFS

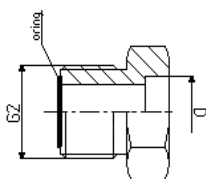

| Ciśnienie BAR | Rura [D] | Gwint [G2] | Oznaczenie CATX ROVS ORFS | |
|------------------|-------------|-----------------------------|-------------------------------------|----------------------------|
| 630 | 6 | 9/16"-18 | CAT XROVS 6 / ORFS 9/16 | |
| | 6 | 11/16"-16 | CAT XROVS 6 / ORFS 11/16 | |
| | 6 | 13/16"-16 | CAT XROVS 6 / ORFS 13/16 | |
| | 8 | 9/16"-18 | CAT XROVS 8 / ORFS 9/16 | |
| | 8 | 11/16"-16 | CAT XROVS 8 / ORFS 11/16 | |
| | 8 | 13/16"-16 | CAT XROVS 8 / ORFS 13/16 | |
| | 10 | 9/16"-18 | CAT XROVS 10 / ORFS 9/16 | |
| | 10 | 11/16"-16 | CAT XROVS 10 / ORFS 11/16 | |
| | 10 | 13/16"-16 | CAT XROVS 10 / ORFS 13/16 | |
| | 10 | 1"-14 | CAT XROVS 10 / ORFS 1 | |
| | 12 | 9/16"-18 | CAT XROVS 12 / ORFS 9/16 | |
| | 12 | 11/16"-16 | CAT XROVS 12 / ORFS 11/16 | |
| | 12 | 13/16"-16 | CAT XROVS 12 / ORFS 13/16 | |
| | 12 | 1"-14 | CAT XROVS 12 / ORFS 1 | |
| | 12 | 1 3/16"-12 | CAT XROVS 12 / ORFS 1 3/16 | |
| | 12 | 1 7/16"-12 | CAT XROVS 12 / ORFS 1 7/16 | |
| | 14 | 11/16"-16 | CAT XROVS 14 / ORFS 11/16 | |
| | 14 | 13/16"-16 | CAT XROVS 14 / ORFS 13/16 | |
| | 420 | 14 | 1"-14 | CAT XROVS 14 / ORFS 1 |
| | | 14 | 1 3/16"-12 | CAT XROVS 14 / ORFS 1 3/16 |
| 14 | | 1 7/16"-12 | CAT XROVS 14 / ORFS 1 7/16 | |
| 15 | | 11/16"-16 | CAT XROVS 15 / ORFS 11/16 | |
| 15 | | 13/16"-16 | CAT XROVS 15 / ORFS 13/16 | |
| 15 | | 1"-14 | CAT XROVS 15 / ORFS 1 | |
| 15 | | 1 3/16"-12 | CAT XROVS 15 / ORFS 1 3/16 | |
| 15 | | 1 7/16"-12 | CAT XROVS 15 / ORFS 1 7/16 | |
| 16 | | 11/16"-16 | CAT XROVS 16 / ORFS 11/16 | |
| 16 | | 13/16"-16 | CAT XROVS 16 / ORFS 13/16 | |
| 16 | | 1"-14 | CAT XROVS 16 / ORFS 1 | |
| 16 | | 1 3/16"-12 | CAT XROVS 16 / ORFS 1 3/16 | |
| 16 | | 1 7/16"-12 | CAT XROVS 16 / ORFS 1 7/16 | |
| 18 | | 13/16"-16 | CAT XROVS 18 / ORFS 13/16 | |
| 18 | | 1"-14 | CAT XROVS 18 / ORFS 1 | |
| 18 | | 1 3/16"-12 | CAT XROVS 18 / ORFS 1 3/16 | |
| 18 | | 1 7/16"-12 | CAT XROVS 18 / ORFS 1 7/16 | |
| 18 | | 1 11/16"-12 | CAT XROVS 18 / ORFS 1 11/16 | |
| 20 | | 13/16"-16 | CAT XROVS 20 / ORFS 13/16 | |
| 20 | | 1"-14 | CAT XROVS 20 / ORFS 1 | |
| 20 | | 1 3/16"-12 | CAT XROVS 20 / ORFS 1 3/16 | |
| 20 | | 1 7/16"-12 | CAT XROVS 20 / ORFS 1 7/16 | |
| 20 | | 1 11/16"-12 | CAT XROVS 20 / ORFS 1 11/16 | |
| 22 | | 13/16"-16 | CAT XROVS 22 / ORFS 13/16 | |
| 22 | | 1"-14 | CAT XROVS 22 / ORFS 1 | |
| 22 | | 1 3/16"-12 | CAT XROVS 22 / ORFS 1 3/16 | |
| 22 | | 1 7/16"-12 | CAT XROVS 22 / ORFS 1 7/16 | |
| 22 | | 1 11/16"-12 | CAT XROVS 22 / ORFS 1 11/16 | |
| 25 | | 13/16"-16 | CAT XROVS 25 / ORFS 13/16 | |
| 25 | | 1"-14 | CAT XROVS 25 / ORFS 1 | |
| 25 | 1 3/16"-12 | CAT XROVS 25 / ORFS 1 3/16 | | |
| 25 | 1 7/16"-12 | CAT XROVS 25 / ORFS 1 7/16 | | |
| 25 | 1 11/16"-12 | CAT XROVS 25 / ORFS 1 11/16 | | |
| 25 | 2"-2 | CAT XROVS 25 / ORFS 2 | | |
| 280 | 28 | 1 7/16"-12 | CAT XROVS 28 / ORFS 1 7/16 | |
| | 28 | 1 11/16"-12 | CAT XROVS 28 / ORFS 1 11/16 | |
| | 28 | 2"-2 | CAT XROVS 28 / ORFS 2 | |
| | 30 | 1 7/16"-12 | CAT XROVS 30 / ORFS 1 7/16 | |
| | 30 | 1 11/16"-12 | CAT XROVS 30 / ORFS 1 11/16 | |
| | 30 | 2"-2 | CAT XROVS 30 / ORFS 2 | |
| | 32 | 1 7/16"-12 | CAT XROVS 32 / ORFS 1 7/16 | |
| | 32 | 1 11/16"-12 | CAT XROVS 32 / ORFS 1 11/16 | |
| | 32 | 2"-2 | CAT XROVS 32 / ORFS 2 | |
| | 35 | 1 11/16"-12 | CAT XROVS 35 / ORFS 1 11/16 | |
| 35 | 2"-2 | CAT XROVS 35 / ORFS 2 | | |
| 38 | 1 11/16"-12 | CAT XROVS 38 / ORFS 1 11/16 | | |
| 38 | 2"-2 | CAT XROVS 38 / ORFS 2 | | |

ELEMENTY ZŁĄCZNE ORFS

CAT WSW ORFS

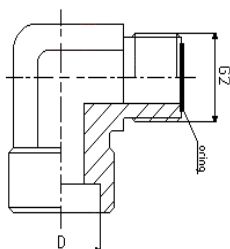

| Ciężnienie BAR | Rura [D] | Gwint [G2] | Oznaczenie CAT WSW ORFS |
|-------------------|-------------|---------------|-----------------------------------|
| 630 | 6 | 9/16"-18 | CAT WSW 6 / ORFS 9/16 |
| | 8 | 11/16"-16 | CAT WSW 8 / ORFS 11/16 |
| | 10 | 11/16"-16 | CAT WSW 10 / ORFS 11/16 |
| | 12 | 13/16"-16 | CAT WSW 12 / ORFS 13/16 |
| 420 | 14 | 1"-14 | CAT WSW 14 / ORFS 1 |
| | 15 | 1"-14 | CAT WSW 15 / ORFS 1 |
| | 16 | 1"-14 | CAT WSW 16 / ORFS 1 |
| | 18 | 1 3/16"-12 | CAT WSW 18 / ORFS 1 3/16 |
| | 20 | 1 3/16"-12 | CAT WSW 20 / ORFS 1 3/16 |
| | 22 | 1 7/16"-12 | CAT WSW 22 / ORFS 1 7/16 |
| | 25 | 1 7/16"-12 | CAT WSW 25 / ORFS 1 7/16 |
| | 28 | 1 11/16"-12 | CAT WSW 28 / ORFS 1 11/16 |
| 280 | 30 | 1 11/16"-12 | CAT WSW 30 / ORFS 1 11/16 |
| | 32 | 1 11/16"-12 | CAT WSW 32 / ORFS 1 11/16 |
| | 35 | 2"-2 | CAT WSW 35 / ORFS 2 |
| | 38 | 2"-2 | CAT WSW 38 / ORFS 2 |

CAT XWSZ ORFS

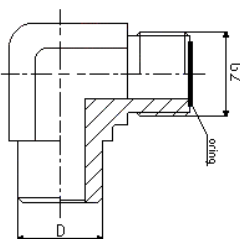

| Ciężnienie BAR | Rura [D] | Gwint [G2] | Oznaczenie CAT XWSZ ORFS |
|-------------------|-------------|---------------|------------------------------------|
| 630 | 6 | 9/16"-18 | CAT XWSZ 6 / ORFS 9/16 |
| | 8 | 11/16"-16 | CAT XWSZ 8 / ORFS 11/16 |
| | 10 | 11/16"-16 | CAT XWSZ 10 / ORFS 11/16 |
| | 12 | 13/16"-16 | CAT XWSZ 12 / ORFS 13/16 |
| 420 | 14 | 1"-14 | CAT XWSZ 14 / ORFS 1 |
| | 15 | 1"-14 | CAT XWSZ 15 / ORFS 1 |
| | 16 | 1"-14 | CAT XWSZ 16 / ORFS 1 |
| | 18 | 1 3/16"-12 | CAT XWSZ 18 / ORFS 1 3/16 |
| | 20 | 1 3/16"-12 | CAT XWSZ 20 / ORFS 1 3/16 |
| | 22 | 1 7/16"-12 | CAT XWSZ 22 / ORFS 1 7/16 |
| | 25 | 1 7/16"-12 | CAT XWSZ 25 / ORFS 1 7/16 |
| | 28 | 1 11/16"-12 | CAT XWSZ 28 / ORFS 1 11/16 |
| 280 | 30 | 1 11/16"-12 | CAT XWSZ 30 / ORFS 1 11/16 |
| | 32 | 1 11/16"-12 | CAT XWSZ 32 / ORFS 1 11/16 |
| | 35 | 2"-2 | CAT XWSZ 35 / ORFS 2 |
| | 38 | 2"-2 | CAT XWSZ 38 / ORFS 2 |

CAT XG M / ORFS

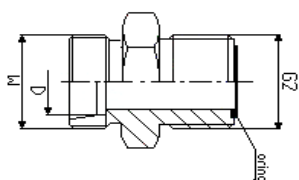

| seria lekka | | | Oznaczenie CAT XG M / ORFS | Oznaczenie CAT XRE M / ORFS |
|-------------|--------------|---------------|--------------------------------------|---------------------------------------|
| Rura [D] | Gwint [M] | Gwint [G2] | | |
| 6 | 12x1,5 | 9/16"-18 | CAT XG 6-M12x1,5 / ORFS 9/16 | CAT XRE 6-M12x1,5 / ORFS 9/16 |
| 8 | 14x1,5 | 9/16"-18 | CAT XG 8-M14x1,5 / ORFS 9/16 | CAT XRE 8-M14x1,5 / ORFS 9/16 |
| 10 | 16x1,5 | 11/16"-16 | CAT XG 10-M16x1,5 / ORFS 11/16 | CAT XRE 10-M16x1,5 / ORFS 11/16 |
| 12 | 18x1,5 | 13/16"-16 | CAT XG 12-M18x1,5 / ORFS 13/16 | CAT XRE 12-M18x1,5 / ORFS 13/16 |
| 15 | 22x1,5 | 1"-14 | CAT XG 15-M22x1,5 / ORFS 1 | CAT XRE 15-M22x1,5 / ORFS 1 |
| 18 | 26x1,5 | 1 3/16"-12 | CAT XG 18-M26x1,5 / ORFS 1 3/16 | CAT XRE 18-M26x1,5 / ORFS 1 3/16 |
| 22 | 30x2 | 1 7/16"-12 | CAT XG 22-M30x2 / ORFS 1 7/16 | CAT XRE 22-M30x2 / ORFS 1 7/16 |
| 28 | 36x2 | 1 11/16"-12 | CAT XG 28-M36x2 / ORFS 1 11/16 | CAT XRE 28-M36x2 / ORFS 1 11/16 |
| 35 | 45x2 | 2"-2 | CAT XG 35-M45x2 / ORFS 2 | CAT XRE 35-M45x2 / ORFS 2 |
| 42 | 52x2 | 2"-2 | CAT XG 42-M52x2 / ORFS 2 | CAT XRE 42-M52x2 / ORFS 2 |

CAT XRE M / ORFS

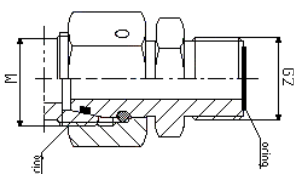

| seria ciężka | | | Oznaczenie CAT XG M / ORFS | Oznaczenie CAT XRE M / ORFS |
|--------------|--------------|---------------|--------------------------------------|---------------------------------------|
| Rura [D] | Gwint [M] | Gwint [G2] | | |
| 6 | 14x1,5 | 9/16"-18 | CAT XG 6-M14x1,5 / ORFS 9/16 | CAT XRE 6-M14x1,5 / ORFS 9/16 |
| 8 | 16x1,5 | 9/16"-18 | CAT XG 8-M16x1,5 / ORFS 9/16 | CAT XRE 8-M16x1,5 / ORFS 9/16 |
| 10 | 18x1,5 | 11/16"-16 | CAT XG 10-M18x1,5 / ORFS 11/16 | CAT XRE 10-M18x1,5 / ORFS 11/16 |
| 12 | 20x1,5 | 13/16"-16 | CAT XG 12-M20x1,5 / ORFS 13/16 | CAT XRE 12-M20x1,5 / ORFS 13/16 |
| 14 | 22x1,5 | 1"-14 | CAT XG 14-M22x1,5 / ORFS 1 | CAT XRE 14-M22x1,5 / ORFS 1 |
| 16 | 24x1,5 | 1"-14 | CAT XG 16-M24x1,5 / ORFS 1 | CAT XRE 16-M24x1,5 / ORFS 1 |
| 20 | 30x2 | 1 3/16"-12 | CAT XG 20-M30x2 / ORFS 1 3/16 | CAT XRE 20-M30x2 / ORFS 1 3/16 |
| 25 | 36x2 | 1 7/16"-12 | CAT XG 25-M36x2 / ORFS 1 7/16 | CAT XRE 25-M36x2 / ORFS 1 7/16 |
| 30 | 42x2 | 1 11/16"-12 | CAT XG 30-M42x2 / ORFS 1 11/16 | CAT XRE 30-M42x2 / ORFS 1 11/16 |
| 38 | 52x2 | 2"-2 | CAT XG 38-M52x2 / ORFS 2 | CAT XRE 38-M52x2 / ORFS 2 |

ELEMENTY ZŁĄCZNE ORFS

CAT XG UNF / ORFS

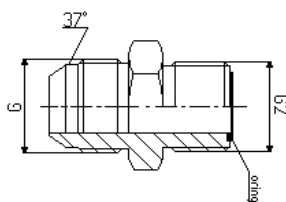

| Ciśnienie BAR | Gwint [G] | Gwint [G2] | Oznaczenie CAT XG UNF / ORFS |
|------------------|--------------|---------------|--|
| 450 | 7/16"-20 | 9/16"-18 | CAT XG UNF 7/16 / ORFS 9/16 |
| | 1/2"-20 | 11/16"-16 | CAT XG UNF 1/2 / ORFS 11/16 |
| 350 | 9/16"-18 | 11/16"-16 | CAT XG UNF 9/16 / ORFS 11/16 |
| | 3/4"-16 | 13/16"-16 | CAT XG UNF 3/4 / ORFS 13/16 |
| | 7/8"-14 | 1"-14 | CAT XG UNF 7/8 / ORFS 1 |
| | 1 1/16"-12 | 1 3/16"-12 | CAT XG UNF 1 1/16 / ORFS 1 3/16 |
| 290 | 1 5/16"-12 | 1 7/16"-12 | CAT XG UNF 1 5/16 / ORFS 1 7/16 |
| 240 | 1 5/8"-12 | 1 11/16"-12 | CAT XG UNF 1 5/8 / ORFS 1 11/16 |
| | 1 7/8"-12 | 2"-2 | CAT XG UNF 1 7/8 / ORFS 2 |

CAT XRE UNF / ORFS

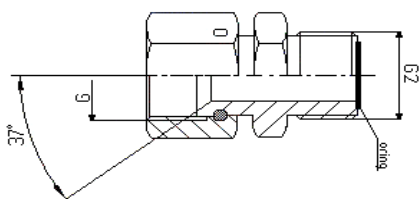

| Ciśnienie BAR | Gwint [G] | Gwint [G2] | Oznaczenie CAT XRE UNF / ORFS |
|------------------|--------------|---------------|---|
| 450 | 7/16"-20 | 9/16"-18 | CAT XRE UNF 7/16 / ORFS 9/16 |
| | 1/2"-20 | 11/16"-16 | CAT XRE UNF 1/2 / ORFS 11/16 |
| 350 | 9/16"-18 | 11/16"-16 | CAT XRE UNF 9/16 / ORFS 11/16 |
| | 3/4"-16 | 13/16"-16 | CAT XRE UNF 3/4 / ORFS 13/16 |
| | 7/8"-14 | 1"-14 | CAT XRE UNF 7/8 / ORFS 1 |
| | 1 1/16"-12 | 1 3/16"-12 | CAT XRE UNF 1 1/16 / ORFS 1 3/16 |
| 290 | 1 5/16"-12 | 1 7/16"-12 | CAT XRE UNF 1 5/16 / ORFS 1 7/16 |
| 240 | 1 5/8"-12 | 1 11/16"-12 | CAT XRE UNF 1 5/8 / ORFS 1 11/16 |
| | 1 7/8"-12 | 2"-2 | CAT XRE UNF 1 7/8 / ORFS 2 |

CAT XRE ORFS / UNF

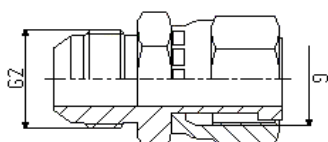

| Ciśnienie BAR | Gwint [G] | Gwint [G2] | Oznaczenie CAT XRE ORFS / UNF |
|------------------|--------------|---------------|---|
| 450 | 9/16"-18 | 7/16"-20 | CAT XRE ORFS 9/16 / UNF 7/16 |
| | 11/16"-16 | 1/2"-20 | CAT XRE ORFS 11/16 / UNF 1/2 |
| 350 | 11/16"-16 | 9/16"-18 | CAT XRE ORFS 11/16 / UNF 9/16 |
| | 13/16"-16 | 3/4"-16 | CAT XRE ORFS 13/16 / UNF 3/4 |
| | 1"-14 | 7/8"-14 | CAT XRE ORFS 1 / UNF 7/8 |
| | 1 3/16"-12 | 1 1/16"-12 | CAT XRE ORFS 1 3/16 / UNF 1 1/16 |
| 290 | 1 7/16"-12 | 1 5/16"-12 | CAT XRE ORFS 1 7/16 / UNF 1 5/16 |
| 240 | 1 11/16"-12 | 1 5/8"-12 | CAT XRE ORFS 1 11/16 / UNF 1 5/8 |
| | 2"-2 | 1 7/8"-12 | CAT XRE ORFS 2 / UNF 1 7/8 |

CAT XG BSP / ORFS

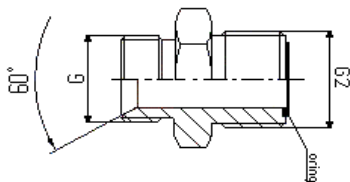

| Ciśnienie BAR | Gwint [G] | Gwint [G2] | Oznaczenie | Oznaczenie |
|------------------|--------------|---------------|---------------------------------|----------------------------------|
| | | | CAT XG BSP / ORFS | CAT XRE BSP / ORFS |
| 630 | 1/8" | 9/16"-18 | CAT XG BSP 1/8 / ORFS 9/16 | CAT XRE BSP 1/8 / ORFS 9/16 |
| | 1/8" | 11/16"-16 | CAT XG BSP 1/8 / ORFS 11/16 | CAT XRE BSP 1/8 / ORFS 11/16 |
| | 1/4" | 9/16"-18 | CAT XG BSP 1/4 / ORFS 9/16 | CAT XRE BSP 1/4 / ORFS 9/16 |
| | 1/4" | 11/16"-16 | CAT XG BSP 1/4 / ORFS 11/16 | CAT XRE BSP 1/4 / ORFS 11/16 |
| | 1/4" | 13/16"-16 | CAT XG BSP 1/4 / ORFS 13/16 | CAT XRE BSP 1/4 / ORFS 13/16 |
| 420 | 1/4" | 1"-14 | CAT XG BSP 1/4 / ORFS 1 | CAT XRE BSP 1/4 / ORFS 1 |
| | 1/4" | 1 3/16"-12 | CAT XG BSP 1/4 / ORFS 1 3/16 | CAT XRE BSP 1/4 / ORFS 1 3/16 |
| | 1/4" | 1 7/16"-12 | CAT XG BSP 1/4 / ORFS 1 7/16 | CAT XRE BSP 1/4 / ORFS 1 7/16 |
| 630 | 3/8" | 9/16"-18 | CAT XG BSP 3/8 / ORFS 9/16 | CAT XRE BSP 3/8 / ORFS 9/16 |
| | 3/8" | 11/16"-16 | CAT XG BSP 3/8 / ORFS 11/16 | CAT XRE BSP 3/8 / ORFS 11/16 |
| | 3/8" | 13/16"-16 | CAT XG BSP 3/8 / ORFS 13/16 | CAT XRE BSP 3/8 / ORFS 13/16 |
| 420 | 3/8" | 1"-14 | CAT XG BSP 3/8 / ORFS 1 | CAT XRE BSP 3/8 / ORFS 1 |
| | 3/8" | 1 3/16"-12 | CAT XG BSP 3/8 / ORFS 1 3/16 | CAT XRE BSP 3/8 / ORFS 1 3/16 |
| | 3/8" | 1 7/16"-12 | CAT XG BSP 3/8 / ORFS 1 7/16 | CAT XRE BSP 3/8 / ORFS 1 7/16 |
| 630 | 1/2" | 9/16"-18 | CAT XG BSP 1/2 / ORFS 9/16 | CAT XRE BSP 1/2 / ORFS 9/16 |
| | 1/2" | 11/16"-16 | CAT XG BSP 1/2 / ORFS 11/16 | CAT XRE BSP 1/2 / ORFS 11/16 |
| | 1/2" | 13/16"-16 | CAT XG BSP 1/2 / ORFS 13/16 | CAT XRE BSP 1/2 / ORFS 13/16 |
| 420 | 1/2" | 1"-14 | CAT XG BSP 1/2 / ORFS 1 | CAT XRE BSP 1/2 / ORFS 1 |
| | 1/2" | 1 3/16"-12 | CAT XG BSP 1/2 / ORFS 1 3/16 | CAT XRE BSP 1/2 / ORFS 1 3/16 |
| | 1/2" | 1 7/16"-12 | CAT XG BSP 1/2 / ORFS 1 7/16 | CAT XRE BSP 1/2 / ORFS 1 7/16 |
| | 3/4" | 11/16"-16 | CAT XG BSP 3/4 / ORFS 11/16 | CAT XRE BSP 3/4 / ORFS 11/16 |
| | 3/4" | 13/16"-16 | CAT XG BSP 3/4 / ORFS 13/16 | CAT XRE BSP 3/4 / ORFS 13/16 |
| | 3/4" | 1"-14 | CAT XG BSP 3/4 / ORFS 1 | CAT XRE BSP 3/4 / ORFS 1 |
| | 3/4" | 1 3/16"-12 | CAT XG BSP 3/4 / ORFS 1 3/16 | CAT XRE BSP 3/4 / ORFS 1 3/16 |
| | 3/4" | 1 7/16"-12 | CAT XG BSP 3/4 / ORFS 1 7/16 | CAT XRE BSP 3/4 / ORFS 1 7/16 |
| | 1" | 1"-14 | CAT XG BSP 1 / ORFS 1 | CAT XRE BSP 1 / ORFS 1 |
| | 1" | 1 3/16"-12 | CAT XG BSP 1 / ORFS 1 3/16 | CAT XRE BSP 1 / ORFS 1 3/16 |
| | 1" | 1 7/16"-12 | CAT XG BSP 1 / ORFS 1 7/16 | CAT XRE BSP 1 / ORFS 1 7/16 |
| 280 | 1" | 1 11/16"-12 | CAT XG BSP 1 / ORFS 1 11/16 | CAT XRE BSP 1 / ORFS 1 11/16 |
| | 1 1/4" | 1 3/16"-12 | CAT XG BSP 1 1/4 / ORFS 1 3/16 | CAT XRE BSP 1 1/4 / ORFS 1 3/16 |
| | 1 1/4" | 1 7/16"-12 | CAT XG BSP 1 1/4 / ORFS 1 7/16 | CAT XRE BSP 1 1/4 / ORFS 1 7/16 |
| | 1 1/4" | 1 11/16"-12 | CAT XG BSP 1 1/4 / ORFS 1 11/16 | CAT XRE BSP 1 1/4 / ORFS 1 11/16 |
| | 1 1/2" | 1 7/16"-12 | CAT XG BSP 1 1/2 / ORFS 1 7/16 | CAT XRE BSP 1 1/2 / ORFS 1 7/16 |
| | 1 1/2" | 1 11/16"-12 | CAT XG BSP 1 1/2 / ORFS 1 11/16 | CAT XRE BSP 1 1/2 / ORFS 1 11/16 |
| | 1 1/2" | 2"-12 | CAT XG BSP 1 1/2 / ORFS 2 | CAT XRE BSP 1 1/2 / ORFS 2 |

CAT XRE BSP / ORFS

